

**3.3 - CAJA RECTANGULAR. A PRUEBA DE INTEMPERIE. SERIE RR.
CON RECUBRIMIENTO EXTERIOR DE PVC E INTERIOR DE URETANO PURPURA.**

**3.3 - WEATHERPROOF SINGLE GANG BOX. RR SERIES.
WITH PVC COATING AND PURPLE URETHANE INNER COATING.**

Hoja: 1 / 4
Page:

FICHA TECNICA / TECHNICAL DATA

007 - RW - 197

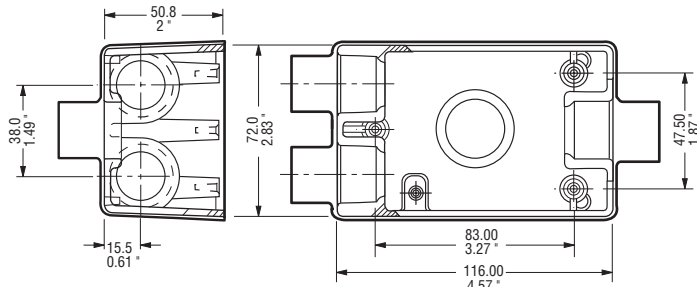

Dimensiones en pulgadas y milímetros.
Dimensions in inches and millimeters.



- A prueba de áreas corrosivas.
- Recubrimiento PVC: 40 mil. mínimo.
- Uretano PURPURA: 2 mil. mínimo.
- Mangas en las entradas para un sellado hermético.
- Material: Aluminio inyectado a presión (diecast).
- Rosca NPT para usarse con tubo conduit RIGIDO e IMC.
- Tornillo de tierra pasivado incluido.
- A prueba de intemperie.

- For use in corrosive atmospheres.
- PVC Coating: 40 mil. min.
- PURPLE Urethane: 2 mil. min.
- Pressure sealing sleeves on conduit openings.
- Material: Diecast aluminum.
- NPT threaded for use with RIGID and IMC conduit.
- Green ground screw included.
- For wet locations.

APLICACIONES:

- Pueden ser instaladas para recibir accesorios como: Interruptores, contactos, estaciones de botones, luces piloto.
- Sirven para hacer empalmes y conexiones en el cableado. Permite fácil acceso para mantenimiento.
- Fabricación en base a: UL 514 A, UL 514 B
CAN/CSA-C22.2 No. 18-92

APPLICATIONS:

- They can be installed to accommodate accessories such as switches, receptacles.
- Provide openings for making splice and taps. Allow access for maintenance.
- Manufactured in compliance with: UL 514 A, UL 514 B
CAN/CSA-C22.2 No. 18-92

USAR No. DE CODIGO PARA HACER PEDIDOS / TO ORDER USE CODE NUMBER

| Figura Figure | Bocas Hubs | Catálogo Catalog | Código Code | Medida nominal Hub size | | Volumen Volume | | Peso x 100 pzas. Weight x 100 pcs. | | Std Pkg. Pzas. Pcs. |
|------------------|---|---------------------|----------------|----------------------------|------|-------------------|--------|---------------------------------------|-------|---------------------------|
| | | | | mm | inch | cm ³ | cu. in | kg | Lb | |
| | Arriba/Top 1 | RR-0505-PC | 01.07.2802.PC | 12.7 | 1/2 | 308.3 | 18.8 | 33.4 | 73.4 | 30 |
| | | RR-0506-PC | 01.07.2803.PC | 19.0 | 3/4 | 308.3 | 18.8 | 34.3 | 75.4 | 30 |
| | | RR-2631-PC | 01.07.2806.PC | 25.4 | 1 | 246.0 | 15.0 | 41.6 | 91.5 | 30 |
| | Arriba/Top 1 Abajo/Bottom 1 | RR-0470-PC | 01.07.2790.PC | 12.7 | 1/2 | 300.1 | 18.3 | 35.1 | 77.2 | 30 |
| | | RR-0471-PC | 01.07.2791.PC | 19.0 | 3/4 | 295.2 | 18.0 | 36.1 | 79.5 | 24 |
| | | RR-2742-PC | 01.07.2807.PC | 25.4 | 1 | 246.0 | 15.0 | 43.3 | 95.3 | 24 |
| | Arriba/Top 1 Abajo/Bottom 2 | RR-0472-PC | 01.07.2792.PC | 12.7 | 1/2 | 275.5 | 16.8 | 45.4 | 99.9 | 30 |
| | | RR-0473-PC | 01.07.2793.PC | 19.0 | 3/4 | 275.5 | 16.8 | 46.1 | 101.6 | 24 |
| | Arriba/Top 1 Abajo/Bottom 1 Izquierda/Left 1 | RR-0480-PC | 01.07.2800.PC | 12.7 | 1/2 | 275.5 | 16.8 | 45.4 | 99.9 | 26 |
| | | RR-0481-PC | 01.07.2801.PC | 19.0 | 3/4 | 275.5 | 16.8 | 46.1 | 101.6 | 20 |
| | | RR-2743-PC | 01.07.2808.PC | 25.4 | 1 | 234.5 | 14.3 | 53.2 | 117.0 | 20 |
| | Arriba/Top 1 Abajo/Bottom 1 Izquierda/Left 1 Derecha/Right 1 | RR-0474-PC | 01.07.2794.PC | 12.7 | 1/2 | 275.5 | 16.8 | 47.6 | 104.7 | 20 |
| | | RR-0475-PC | 01.07.2795.PC | 19.0 | 3/4 | 275.5 | 16.8 | 48.8 | 107.3 | 16 |
| | | RR-2744-PC | 01.07.2809.PC | 25.4 | 1 | 234.5 | 14.3 | 55.4 | 121.8 | 16 |

Especificaciones sujetas a cambio sin previo aviso. Specifications are subject to change without notice.

RAWELT, S.A. de C.V.



22 - V - 2009

**3.3 - CAJA RECTANGULAR. A PRUEBA DE INTEMPERIE. SERIE RR.
CON RECUBRIMIENTO EXTERIOR DE PVC E INTERIOR DE URETANO PURPURA.**

**3.3 - WEATHERPROOF SINGLE GANG BOX. RR SERIES.
WITH PVC COATING AND PURPLE URETHANE INNER COATING.**

Hoja: 2 / 4
Page:

FICHA TECNICA / TECHNICAL DATA

007 - RW - 197

USAR No. DE CODIGO PARA HACER PEDIDOS / TO ORDER USE CODE NUMBER

| Figura Figure | Bocas Hubs | Catálogo Catalog | Código Code | Medida nominal Hub size | | Volumen Volume | | Peso x 100 pzas. Weight x 100 pcs. | | Std Pkg. Pzas. Pcs. | |
|------------------|----------------|---------------------|----------------|----------------------------|------|-------------------|--------|---------------------------------------|------|------------------------------|----|
| | | | | mm | inch | cm ³ | cu. in | kg | Lb | | |
| | Arriba/Top | 2 | RR-0476-PC | 01.07.2796.PC | 12.7 | 1/2 | 267.3 | 16.3 | 47.6 | 104.7 | 30 |
| | Abajo/Bottom | 2 | RR-0477-PC | 01.07.2797.PC | 19.0 | 3/4 | 267.3 | 16.3 | 48.8 | 107.3 | 24 |
| | Arriba/Top | 1 | RR-0478-PC | 01.07.2798.PC | 12.7 | 1/2 | 267.3 | 16.3 | 50.2 | 110.4 | 20 |
| | Abajo/Bottom | 1 | RR-0479-PC | 01.07.2799.PC | 19.0 | 3/4 | 267.3 | 16.3 | 51.7 | 113.7 | 16 |
| | Izquierda/Left | 2 | | | | | | | | | |
| | Derecha/Right | 1 | | | | | | | | | |
| | Arriba/Top | 1 | RR-0507-PC | 01.07.2804.PC | 12.7 | 1/2 | 308.3 | 18.8 | | | |
| | Detrás/Back | 1 | RR-0508-PC | 01.07.2805.PC | 19.0 | 3/4 | 303.4 | 18.5 | | | |
| | | | RR-2745-PC | 01.07.2810.PC | 25.4 | 1 | 246.0 | 15.0 | | | |
| | Arriba/Top | 1 | RR-0281-PC | 01.07.2778.PC | 12.7 | 1/2 | 300.1 | 18.3 | | | |
| | Abajo/Bottom | 1 | RR-0282-PC | 01.07.2779.PC | 19.0 | 3/4 | 295.2 | 18.0 | | | |
| | Detrás/Back | 1 | RR-2746-PC | 01.07.2811.PC | 25.4 | 1 | 246.0 | 15.0 | | | |
| | Arriba/Top | 1 | RR-0283-PC | 01.07.2780.PC | 12.7 | 1/2 | 275.5 | 16.8 | | | |
| | Abajo/Bottom | 2 | RR-0284-PC | 01.07.2781.PC | 19.0 | 3/4 | 275.5 | 16.8 | | | |
| | Arriba/Top | 1 | RR-0454-PC | 01.07.2788.PC | 12.7 | 1/2 | 275.5 | 16.8 | | | |
| | Abajo/Bottom | 1 | RR-0455-PC | 01.07.2789.PC | 19.0 | 3/4 | 275.5 | 16.8 | | | |
| | Izquierda/Left | 1 | RR-2747-PC | 01.07.2812.PC | 25.4 | 1 | 234.5 | 14.3 | | | |
| | Arriba/Top | 1 | RR-0285-PC | 01.07.2782.PC | 12.7 | 1/2 | 275.5 | 16.8 | | | |
| | Abajo/Bottom | 1 | RR-0286-PC | 01.07.2783.PC | 19.0 | 3/4 | 275.5 | 16.8 | | | |
| | Izquierda/Left | 1 | RR-2748-PC | 01.07.2813.PC | 25.4 | 1 | 234.5 | 14.3 | | | |
| | Derecha/Right | 1 | | | | | | | | | |
| | Arriba/Top | 2 | RR-0287-PC | 01.07.2784.PC | 12.7 | 1/2 | 267.3 | 16.3 | | | |
| | Abajo/Bottom | 2 | RR-0288-PC | 01.07.2785.PC | 19.0 | 3/4 | 267.3 | 16.3 | | | |
| | Detrás/Back | 1 | | | | | | | | | |
| | Arriba/Top | 1 | RR-0289-PC | 01.07.2786.PC | 12.7 | 1/2 | 267.3 | 16.3 | | | |
| | Abajo/Bottom | 1 | RR-0290-PC | 01.07.2787.PC | 19.0 | 3/4 | 267.3 | 16.3 | | | |
| | Izquierda/Left | 2 | | | | | | | | | |
| | Derecha/Right | 1 | | | | | | | | | |
| | Detrás/Back | 1 | | | | | | | | | |

Certificaciones / Compliances: Expediente/File No. LR 105795-1

Expediente/File No. E135600

Cajas 25.4 1"
 Boxes 25.4 1"

Especificaciones sujetas a cambio sin previo aviso. Specifications are subject to change without notice.

RAWELT, S.A. de C.V.

RAWELT INYECTADOS

Una División del Grupo **REVELTA**

22 - V - 2009

**3.3 - CAJA RECTANGULAR. A PRUEBA DE INTEMPERIE. SERIE RR.
CON RECUBRIMIENTO EXTERIOR DE PVC E INTERIOR DE URETANO PURPURA.**

Hoja: 3 / 4
Page:

**3.3 - WEATHERPROOF SINGLE GANG BOX. RR SERIES.
WITH PVC COATING AND PURPLE URETHANE INNER COATING.**

FICHA TECNICA / TECHNICAL DATA

007-RW-197

TAPA

- Recubrimiento PVC: 40 mil. mínimo.
- Uretano PURPURA: 2 mil. mínimo.
- Lámina de aluminio troquelada.
- Tornillos de acero inoxidable incluidos.

COVER

- PVC coating: 40 mil. min.
- PURPLE Urethane: 2 mil. min.
- Sheet aluminum.
- Stainless steel screws included.

CLOSE UP PLUG

- Die cast aluminum.

TAPON

- Aluminio inyectado a presión (diecast).

Dimensiones en milímetros y pulgadas.
Dimensions in inches and millimeters.

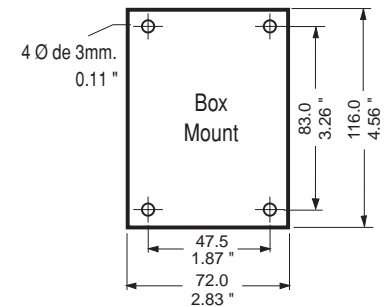
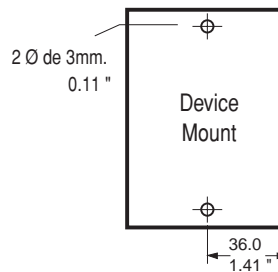

LISTED
1M70



USAR No. DE CODIGO PARA HACER PEDIDOS / TO ORDER USE CODE NUMBER

| Figura Figure | Catálogo Catalog | Código Code | Descripción Description | Cant. Diam. Qty. | Espesor Thickness | | Peso x 100 pzas. Weight x 100 pcs. | | Unit. Ctn. Pzas. Pcs. | Ship Ctn. Pzas. Pcs. | Std Pkg. Pzas. Pcs. |
|------------------|---------------------|----------------|--|------------------------|----------------------|------|---------------------------------------|----|--------------------------------|-------------------------------|------------------------------|
| | | | | | mm | inch | kg | Lb | | | |
| | TR-0424-PC | 01.08.2822.PC | Tapa rectangular para contacto de 35.23 mm Ø 1 3/8". Single gang round receptacle cover 1 3/8" diameter hole. Box mount. | 4 | 1.02 | .040 | | | 50 | 150 | |
| | TR-0414-PC | 01.08.2815.PC | Tapa rectangular para contacto de 40.38 mm Ø 1 9/16". Single gang round receptacle cover 1 9/16" diameter hole. Box mount. | 4 | 1.02 | .040 | | | 50 | 150 | |
| | TR-0426-PC | 01.08.2824.PC | Tapa rectangular para contacto de 35.23 mm Ø 1 3/8". Single gang round receptacle cover 2 1/8" diameter hole. Box mount. | 4 | 1.02 | .040 | | | 50 | 150 | |
| | TR-0425-PC | 01.08.2823.PC | Tapa rectangular para contacto de 35.23 mm Ø 1 3/8". Single gang round receptacle cover 1 3/8" diameter hole. Device mount. | 2 | 1.02 | .040 | | | 50 | 150 | |
| | TR-0423-PC | 01.08.2821.PC | Tapa rectangular para contacto de 40.38 mm Ø 1 9/16". Single gang round receptacle cover 1 9/16" diameter hole. Device mount. | 2 | 1.02 | .040 | | | 50 | 150 | |
| | TR-0427-PC | 01.08.2825.PC | Tapa rectangular para contacto de 54.30 mm Ø 2 1/8". Single gang round receptacle cover 2 1/8" diameter hole. Device mount. | 2 | 1.02 | .040 | | | 50 | 150 | |
| | TR-0415-PC | 01.08.2816.PC | Tapa rectangular para interruptor Single gang toggle switch cover. Box mount. | 4 | 1.02 | .040 | | | 50 | 150 | |

Especificaciones sujetas a cambio sin previo aviso. Specifications are subject to change without notice..

RAWELT, S.A. de C.V.



Una División del Grupo REVUELTA

16 - VI - 2009

**3.3 - CAJA RECTANGULAR. A PRUEBA DE INTEMPERIE. SERIE RR.
CON RECUBRIMIENTO EXTERIOR DE PVC E INTERIOR DE URETANO PURPURA.**

**3.3 - WEATHERPROOF SINGLE GANG BOX. RR SERIES.
WITH PVC COATING AND PURPLE URETHANE INNER COATING.**

Hoja: 4 / 4
Page:

FICHA TECNICA / TECHNICAL DATA

007-RW-197

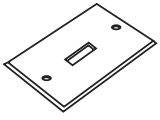
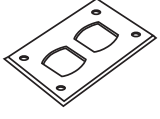
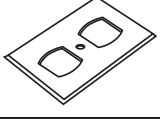
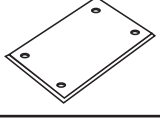
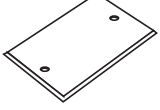

USAR No. DE CODIGO PARA HACER PEDIDOS / TO ORDER USE CODE NUMBER

| Figura Figure | Catálogo Catalog | Código Code | Descripción Description | Cant. Diam. Qty. | Espesor Thickness | | Peso x 100 pzas. Weight x 100 pcs. | | Unit. Ctn. Pzas. Pcs. | Ship Ctn. Pzas. Pcs. | Std. Pkg. Pzas. Pcs. |
|---|---------------------|----------------|---|------------------------|----------------------|------|---------------------------------------|-----|--------------------------------|-------------------------------|-------------------------------|
| | | | | | mm | inch | kg | Lb | | | |
|  | TR-0421-PC | 01.08.2819.PC | Tapa rectangular para interruptor Single gang toggle switch cover. Device mount. | 2 | 1.02 | .040 | | | 50 | 150 | |
|  | TR-0385-PC | 01.08.2814.PC | Tapa rectangular para contacto duplex. Single gang duplex receptacle cover. Box mount. | 4 | 1.02 | .040 | 2.0 | 4.4 | 50 | 150 | |
|  | TR-0422-PC | 01.08.2820.PC | Tapa rectangular para contacto duplex. Single gang duplex receptacle cover. Device mount. | 1 | 1.02 | .040 | 1.9 | 4.2 | 50 | 150 | |
|  | TR-0416-PC | 01.08.2817.PC | Tapa rectangular ciega. Weatherproof single gang blank cover. Box mount. | 4 | 1.02 | .040 | 2.4 | 5.3 | 50 | 150 | |
|  | TR-0420-PC | 01.08.2818.PC | Tapa rectangular ciega. Weatherproof single gang blank cover. Device mount. | 2 | 1.02 | .040 | 2.4 | 5.3 | 50 | 150 | |

TAPONES / PLUGS

USAR No. DE CODIGO PARA HACER PEDIDOS / TO ORDER USE CODE NUMBER

| Figura Figure | Catálogo Catalog | Código Code | Descripción Description | Medida nominal Hub size | | Peso x 100 pzas. Weight x 100 pcs. | | Pqt. Unit Pzas. Pcs. | Unit Ctn. Pzas. Pcs. | Ship Ctn. Pzas. Pcs. |
|---|---------------------|----------------|----------------------------|-------------------------------|------|---------------------------------------|----|-------------------------------|-------------------------------|-------------------------------|
| | | | | mm. | inch | Kg | Lb | | | |
| | | | | | | | | | | |
|  | TA-0371-EX | 01.09.2829.EX | Tapón roscado. | 12.7 | 1/2 | | | 25 | 200 | 2000 |
| | TA-0368-EX | 01.09.2828.EX | Close-up plug. | 19.0 | 3/4 | | | 25 | 100 | 1000 |
| | TA-2632-EX | 01.09.2830.EX | | 25.4 | 1 | | | 25 | 100 | 1000 |

Certificaciones / Compliances:  Expediente/File No. LR 105795-1  Expediente/File No. E135600
 Tapones
 Closure plugs

Especificaciones sujetas a cambio sin previo aviso. Specifications are subject to change without notice.

RAWELT, S.A. de C.V.

 **RAWELT** INYECTADOS
Una División del Grupo **REBUelta** 

16 - VI - 2009



Cotización/Quotation Plazo de embarque* / Shipment exw* :

Pedido No./Purchase order :

Our ref.:

Fecha/Date: Vendedor/Salesman:

No.

Facturar a/Invoice to: RFC.

Ordenado por/Ordered by: Tel. () Fax ()

Dirección/Address:

C.P./Zip. Lugar/City/Country:

Consignar a/Ship to:

Embarcar: Camión x Cobrar Pagado Paquete

Cond. de Pago/Terms:

Cond. de Venta/Sale conditions: L.P.:

| 3.3 - SERIE RR - PC. CAJA RECTANGULAR A PRUEBA DE INTEMPERIE. CON PVC / WEATHERPROOF SINGLE GANG BOX WITH PVC COATING. | | | | | | | | | | | | | | |
|--|----------------|----------------------------|------|---------------|---------------|--------------|--------------|------------------|------------------|----------------|----------------------------|------|--------------|------------------|
| Figura Figure | Código Code | Medida nominal Hub size | | Pqt. Unit. | Unit. Ctn. | Ship Ctn. | Std. Pkg. | Cantidad Qty. | Figura Figure | Código Code | Medida nominal Hub size | | Std. Pkg. | Cantidad Qty. |
| | | mm | inch | | | | | | | | mm | inch | | |
| | 01.07.2802.PC | 12.7 | 1/2 | | | | 30 | | | 01.07.2804.PC | 12.7 | 1/2 | | |
| | 01.07.2803.PC | 19.0 | 3/4 | | | | 30 | | | 01.07.2805.PC | 19.0 | 3/4 | | |
| | 01.07.2806.PC | 25.4 | 1 | | | | 30 | | | 01.07.2810.PC | 25.4 | 1 | | |
| | 01.07.2790.PC | 12.7 | 1/2 | | | | 30 | | | 01.07.2778.PC | 12.7 | 1/2 | | |
| | 01.07.2791.PC | 19.0 | 3/4 | | | | 24 | | | 01.07.2779.PC | 19.0 | 3/4 | | |
| | 01.07.2807.PC | 25.4 | 1 | | | | 24 | | | 01.07.2811.PC | 25.4 | 1 | | |
| | 01.07.2792.PC | 12.7 | 1/2 | | | | 30 | | | 01.07.2780.PC | 12.7 | 1/2 | | |
| | 01.07.2793.PC | 19.0 | 3/4 | | | | 24 | | | 01.07.2781.PC | 19.0 | 3/4 | | |
| | 01.07.2800.PC | 12.7 | 1/2 | | | | 26 | | | 01.07.2788.PC | 12.7 | 1/2 | | |
| | 01.07.2801.PC | 19.0 | 3/4 | | | | 20 | | | 01.07.2789.PC | 19.0 | 3/4 | | |
| | 01.07.2808.PC | 25.4 | 1 | | | | 20 | | | 01.07.2812.PC | 25.4 | 1 | | |
| | 01.07.2794.PC | 12.7 | 1/2 | | | | 20 | | | 01.07.2782.PC | 12.7 | 1/2 | | |
| | 01.07.2795.PC | 19.0 | 3/4 | | | | 16 | | | 01.07.2783.PC | 19.0 | 3/4 | | |
| | 01.07.2809.PC | 25.4 | 1 | | | | 16 | | | 01.07.2813.PC | 25.4 | 1 | | |
| | 01.07.2796.PC | 12.7 | 1/2 | | | | 30 | | | 01.07.2784.PC | 12.7 | 1/2 | | |
| | 01.07.2797.PC | 19.0 | 3/4 | | | | 24 | | | 01.07.2785.PC | 19.0 | 3/4 | | |
| | 01.07.2798.PC | 12.7 | 1/2 | | | | 20 | | | 01.07.2786.PC | 12.7 | 1/2 | | |
| | 01.07.2799.PC | 19.0 | 3/4 | | | | 16 | | | 01.07.2787.PC | 19.0 | 3/4 | | |
| | 01.09.2829.PC | 12.7 | 1/2 | 25 | 200 | 2000 | | | | | | | | |
| | 01.09.2828.PC | 19.0 | 3/4 | 25 | 100 | 1000 | | | | | | | | |
| | 01.09.2830.PC | 25.4 | 1 | 25 | 100 | 1000 | | | | | | | | |

Expediente
 Control
 Embarques
 Almacén
 Producción

- Antes de fincar el pedido en firme, favor de confirmar con fábrica el plazo de embarque definitivo.
- Before place your order, please confirm with RAWELT definitive date of shipment.



Cotización/Quotation Plazo de embarque* / Shipment exw* :

Pedido No./Purchase order :

Our ref.:

Fecha/Date: Vendedor/Salesman: No.

Facturar a/Invoice to: RFC.

Ordenado por/Ordered by: Tel. () Fax ()

Dirección/Address:

C.P./Zip. Lugar/City/Country:

Consignar a/Ship to:

Embarcar: Camión x Cobrar Pagado Paquete

Cond. de Pago/Terms:

Cond. de Venta/Sale conditions: L.P.:

| 3.3 - SERIE RR-PC. TAPA PVC / COVER WITH PVC COATING | | | | | | | 4.3 - SERIE RC-PC. TAPA PVC / COVER WITH PVC COATING | | | | | | |
|--|------------------|----------------------|---------------|--------------|-------------------------------|------------------|--|----------------|---------------|---------------|-------------------------------|------------------|--|
| Figura Figure | Código Código | Diametro Diameter | Unit. Ctn. | Ship Ctn. | Std. Pkg. Pzas. Pcs. | Cantidad Qty. | Figura Figure | Código Code | Unit. Ctn. | Ship Ctn. | Std. Pkg. Pzas. Pcs. | Cantidad Qty. | |
| | 01.08.2822.PC | Ø 35.23 mm | 50 | 150 | | | | 02.07.2875.PC | 30 | 90 | | | |
| | 01.08.2815.PC | Ø 40.38 mm | 50 | 150 | | | | | 02.07.2878.PC | 30 | 90 | | |
| | 01.08.2824.PC | Ø 54.30 mm | 50 | 150 | | | | | | 02.07.2877.PC | 30 | 90 | |
| | 01.08.2823.PC | Ø 35.23 mm | 50 | 150 | | | | | | 02.07.2880.PC | 30 | 90 | |
| | 01.08.2821.PC | Ø 40.38 mm | 50 | 150 | | | | | | 02.07.2881.PC | 30 | 90 | |
| | 01.08.2825.PC | Ø 54.30 mm | 50 | 150 | | | | | | 02.07.2882.PC | 30 | 90 | |
| | 01.08.2816.PC | | 50 | 150 | | | | | | 02.07.2876.PC | 30 | 90 | |
| | 01.08.2819.PC | | 50 | 150 | | | | | | 02.07.2879.PC | 30 | 90 | |
| | 01.08.2814.PC | | 50 | 150 | | | | | | | | | |
| | 01.08.2820.PC | | 50 | 150 | | | | | | | | | |
| | 01.08.2817.PC | | 50 | 150 | | | | | | | | | |
| | 01.08.2818.PC | | 50 | 150 | | | | | | | | | |

Expediente
 Control
 Embarques
 Almacén
 Producción

- Antes de fincar el pedido en firme, favor de confirmar con fábrica el plazo de embarque definitivo.
- Before place your order, please confirm with RAWELT definitive date of shipment.