

PRODUCTOS PARA INSTALACIONES ELECTRICAS

Products for electrical installations

INYECTADOS



RAWELT®

DIECAST



Cajas para áreas peligrosas libres de cobre



Cajas Ovais

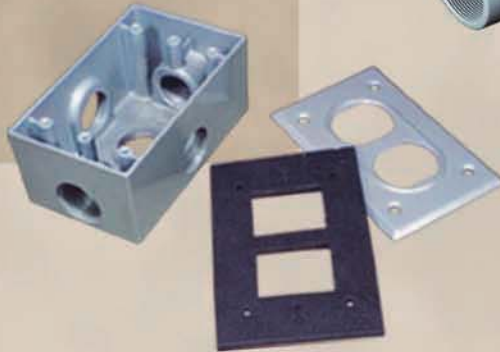

Cajas Rectangulares y Cuadradas

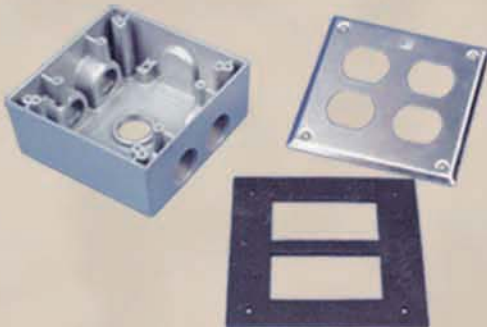

Cajas Unión



Luminarias a prueba de intemperie



Tuercas Unión para áreas peligrosas



Sellos para áreas peligrosas



Luminaria Industrial HID para áreas peligrosas

Lámparas Luz de Obstrucción



Vaso de Cristal

Lámparas a prueba de vapor



Vaso de Policarbonato

Folleto RW 20

4.1 - CAJA CUADRADA. A PRUEBA DE INTEMPERIE. SERIE RC.

4.1 - WEATHERPROOF TWO GANG BOX. RC SERIES.

Dimensiones en milímetros y en pulgadas.
Dimensions in inches and millimeters.

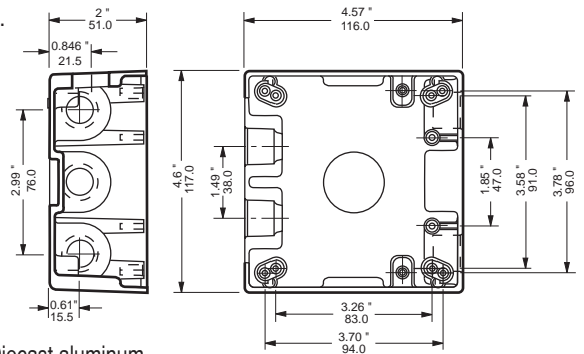

- Material: Aluminio inyectado a presión (diecast).
- Acabados: Pintura electrostática epoxica/poliéster polimerizada.
- Dos tornillos de tierra pasivados incluidos.
- A prueba de intemperie cuando se usa tapa con empaque.
- Rosca NPT para usarse con tubo conduit RIGIDO e IMC.

APLICACIONES:

- Pueden ser instaladas para recibir accesorios como: Interruptores, contactos, estaciones de botones, luces piloto.
- Sirven para hacer empalmes y conexiones en el cableado. Permite facil acceso para mantenimiento.
- Fabricación en base a: UL 514 A, UL 514 B
CAN/CSA-C22.2 No. 18-92

- Material: Diecast aluminum.
- Finish: Electrostatic powder epoxy/poliéster coating.
- Two green ground screws included.
- For wet location when gasketed cover are used.
- NPT threaded for use with RIGID and IMC conduit.

APPLICATIONS:

- They can be installed to accommodate accessories such as switches, receptacles.
- Provide openings for making splice and taps. Allow access for maintenance.
- Manufactured in compliance with: UL 514 A, UL 514 B
CAN/CSA-C22.2 No. 18-92

USAR No. DE CODIGO PARA HACER PEDIDOS / TO ORDER USE CODE NUMBER

Figura Figure	Bocas Hubs	Catalogo Catalog	Codigo Code	Medida nominal Hub size		Volumen Volume		Peso x 100 pzas. Weight x 100 pcs.		Pqt. Unit. Pzas. Pcs.	Unit. Ctn. Pzas. Pcs.	Ship Ctn. Pzas. Pcs.	Std. Pkg. Pzas. Pcs.
				mm	inch	cm ³	cu. in	kg	Lb				
	Arriba/Top	1	RC-0482	02.01.0482	12.7	1/2	492.0	30.0	42.5	93.6			24
	Abajo/Bottom	1	RC-0483	02.01.0483	19.0	3/4	492.0	30.0	41.0	90.3			24
	Arriba/Top	2	RC-0484	02.01.0484	12.7	1/2	483.8	29.5	42.5	93.6			24
	Abajo/Bottom	1	RC-0485	02.01.0485	19.0	3/4	483.8	29.5	39.0	85.9			24
	Arriba/Top	1	RC-0502	02.01.0502	12.7	1/2	492.0	30.0	42.0	92.5			24
	Abajo/Bottom	1	RC-0503	02.01.0503	19.0	3/4	492.0	30.0	39.5	87.0			24
	Izquierda/Left	1	RC-0503	02.01.0503	19.0	3/4	492.0	30.0	39.5	87.0			24
	Arriba/Top	1	RC-0486	02.01.0486	12.7	1/2	492.0	30.0	41.5	91.4			24
	Abajo/Bottom	1	RC-0487	02.01.0487	19.0	3/4	492.0	30.0	39.0	85.9			24
	Izquierda/Left	1	RC-0487	02.01.0487	19.0	3/4	492.0	30.0	39.0	85.9			24
	Derecha/Right	1	RC-0487	02.01.0487	19.0	3/4	492.0	30.0	39.0	85.9			24
	Arriba/Top	2	RC-0488	02.01.0488	12.7	1/2	475.0	29.5	48.38	91.4			24
	Abajo/Bottom	1	RC-0489	02.01.0489	19.0	3/4	475.0	29.5	48.38	83.7			24
	Izquierda/Left	1	RC-0489	02.01.0489	19.0	3/4	475.0	29.5	48.38	83.7			24

Especificaciones sujetas a cambio sin previo aviso. Specifications are subject to change without notice.

RAWELT, S.A. de C.V.



4.1 - CAJA CUADRADA. A PRUEBA DE INTEMPERIE. SERIE RC.

Hoja: 2 / 6
Page:

4.1 - WEATHERPROOF TWO GANG BOX. RC SERIES.

FICHA TECNICA / TECHNICAL DATA

007-RW-155

USAR No. DE CODIGO PARA HACER PEDIDOS / TO ORDER USE CODE NUMBER

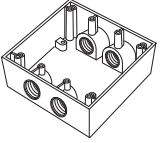
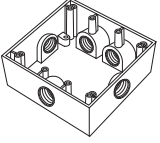
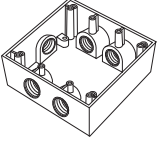
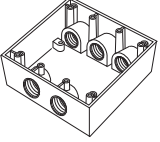
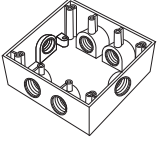
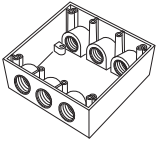
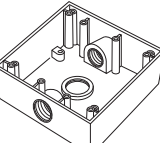
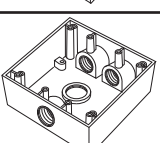
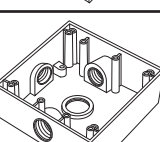
Figura Figure	Bocas Hubs	Catalogo Catalog	Codigo Code	Medida nominal Hub size		Volumen Volume		Peso x 100 pzas. Weight x 100 pcs.		Pqt. Unit. Pzas. Pcs.	Unit. Ctn. Pzas. Pcs.	Ship Ctn. Pzas. Pcs.	Std. Pkg. Pzas. Pcs.
				mm	inch	cm ³	cu. in	kg	Lb				
	Arriba/Top 2	RC-0492	02.01.0492	12.7	1/2	480.5	29.3	43.0	94.7				24
	Abajo/Bottom 2	RC-0493	02.01.0493	19.0	3/4	480.5	29.3	38.0	83.7				24
	Arriba/Top 2	RC-0490	02.01.0490	12.7	1/2	483.8	29.5	41.0	90.3				24
	Abajo/Bottom 1	RC-0491	02.01.0491	19.0	3/4	483.8	29.5	37.0	81.5				24
	Izquierda/Left 1												
	Derecha/Right 1												
	Arriba/Top 2	RC-0494	02.01.0494	12.7	1/2	480.5	29.3	42.0	92.5				24
	Abajo/Bottom 2	RC-0495	02.01.0495	19.0	3/4	480.5	29.3	37.0	81.5				24
	Izquierda/Left 1												
	Arriba/Top 3	RC-0498	02.01.0498	12.7	1/2	475.6	29.0	44.5	98.1				24
	Abajo/Bottom 2	RC-0499	02.01.0499	19.0	3/4	475.6	29.0	39.5	87.0				24
	Arriba/Top 2	RC-0496	02.01.0496	12.7	1/2	480.5	29.3	41.5	91.4				24
	Abajo/Bottom 2	RC-0497	02.01.0497	19.0	3/4	480.5	29.3	36.0	79.3				24
	Izquierda/Left 1												
	Derecha/Right 1												
	Arriba/Top 3	RC-0500	02.01.0500	12.7	1/2	472.3	28.8	45.0	99.2				24
	Abajo/Bottom 3	RC-0501	02.01.0501	19.0	3/4	472.3	28.8	38.5	84.8				24
	Arriba/Top 1	RC-0279	02.01.0279	12.7	1/2	492.0	30.0	42.0	92.5				24
	Abajo/Bottom 1	RC-0280	02.01.0280	19.0	3/4	492.0	30.0	40.5	89.2				24
	Detrás/Back 1												
	Arriba/Top 2	RC-0327	02.01.0327	12.7	1/2	483.8	29.5	42.0	92.5				24
	Abajo/Bottom 1	RC-0328	02.01.0328	19.0	3/4	483.8	29.5	38.5	84.8				24
	Detrás/Back 1												
	Arriba/Top 1	RC-0406	02.01.0406	12.7	1/2	492.0	30.0	41.5	91.4				24
	Abajo/Bottom 1	RC-0407	02.01.0407	19.0	3/4	492.0	30.0	39.0	85.9				24
	Izquierda/Left 1												
	Detrás/Back 1												

Especificaciones sujetas a cambio sin previo aviso. Specifications are subject to change without notice.

RAWELT, S.A. de C.V.



Una División del Grupo REVUELTA

22 - V - 2009

4.1 - CAJA CUADRADA. A PRUEBA DE INTEMPERIE. SERIE RC.

4.1 - WEATHERPROOF TWO GANG BOX. RC SERIES.

FICHA TECNICA / TECHNICAL DATA

007-RW-155

USAR No. DE CODIGO PARA HACER PEDIDOS / TO ORDER USE CODE NUMBER

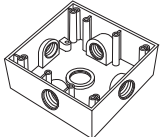
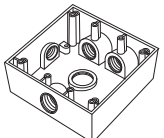
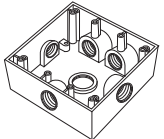
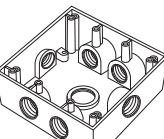
Figura Figure	Bocas Hubs	Catalogo Catalog	Codigo Code	Medida nominal Hub size		Volumen Volume		Peso x 100 pzas. Weight x 100 pcs.		Pqt. Unit. Pzas. Pcs.	Unit. Ctn. Pzas. Pcs.	Ship Ctn. Pzas. Pcs.	Std. Pkg. Pzas. Pcs.
				mm	inch	cm ³	cu. in	kg	Lb				
	1	RC-0390	02.01.0390	12.7	1/2	492.0	30.0	41.0	90.3				24
	1		02.01.0391	19.0	3/4	492.0	30.0	38.5	84.8				24
	1	RC-0392	02.01.0392	12.7	1/2	483.8	29.5	41.0	90.3				24
	1		02.01.0393	19.0	3/4	483.8	29.5	37.5	82.6				24
	2	RC-0396	02.01.0396	12.7	1/2	480.5	29.3	42.5	93.6				24
	2		02.01.0397	19.0	3/4	480.5	29.3	37.5	82.6				24
	1	RC-0394	02.01.0394	12.7	1/2	483.8	29.5	40.5	89.2				24
1	02.01.0395		19.0	3/4	483.8	29.5	36.5	80.4				24	
	2	RC-0398	02.01.0398	12.7	1/2	480.5	29.3	41.5	91.4				24
	2		02.01.0399	19.0	3/4	480.5	29.3	36.5	80.4				24
	1	RC-0402	02.01.0402	12.7	1/2	475.6	29.0	44.0	97.0				24
	1		02.01.0403	19.0	3/4	475.6	29.0	39.0	85.9				24
	2	RC-0400	02.01.0400	12.7	1/2	480.5	29.3	41.0	90.3				24
	2		02.01.0401	19.0	3/4	480.5	29.3	35.5	78.2				24
	1	RC-0404	02.01.0404	12.7	1/2	472.3	28.8	44.5	98.1				24
	1		02.01.0405	19.0	3/4	472.3	28.8	38.0	83.7				24

Certificaciones / Compliances:  Expediente/File No. LR 105795-1  Expediente/File No. E135600

Especificaciones sujetas a cambio sin previo aviso. Specifications are subject to change without notice.

RAWELT, S.A. de C.V.

 **RAWELT** INYECTADOS

Una División del Grupo  **REVUELTA**

22 - V - 2009

4.1 - CAJA CUADRADA. A PRUEBA DE INTEMPERIE. SERIE RC.

Hoja: 4 / 6
Page:

4.1 - WEATHERPROOF TWO GANG BOX. RC SERIES.

FICHA TECNICA / TECHNICAL DATA

007-RW-155

TAPA

- Lámina de aluminio troquelada.
- Uso en interiores.
- Tornillos galvanizados incluidos.

COVER

- Sheet aluminum.
- For use in interiors.
- Galvanized mounting screws included.

EMPAQUE

- Neopreno

GASKET

- Neoprene.

TAPON

- Aluminio inyectado a presión.(die cast)

CLOSE UP PLUG

- Die cast aluminum.

Dimensiones en milímetros y pulgadas.
Dimensions in inches and millimeters.

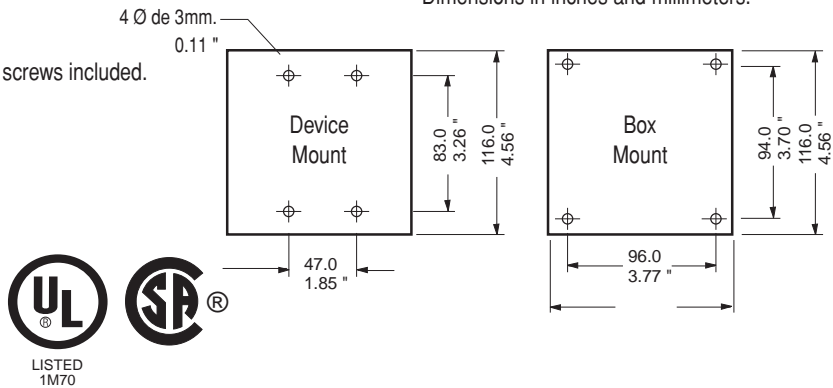

USAR No. DE CODIGO PARA HACER PEDIDOS / TO ORDER USE CODE NUMBER

Figura Figure	Catalogo Catalog	Codigo Code	Descripción Description	Cant. Diam. Qty.	Espesor Thickness		Peso x 100 pzas. Weight x 100 pcs.		Pqt. Unit Pzas. Pcs.	Unit Ctn. Pzas. Pcs.	Ship Ctn. Pzas. Pcs.	Std. Pkg. Pzas. Pcs.
					mm	inch	kg	Lb				
	TC-0417	02.02.0417	Tapa cuadrada para dos contactos duplex. Two gang two duplex receptacles cover. Box mount.	4	1.02	.040	2.9	6.4	10	40	160	200
	TC-0457	02.02.0457	Tapa cuadrada para dos contactos duplex. Two gang two duplex receptacles cover. Device mount.	2	1.02	.040	3.0	6.6	10	40	160	200
	TC-0419	02.02.0419	Tapa cuadrada para dos interruptores. Two gang two toggles switches cover. Box mount.	4	1.02	.040	3.7	8.2	10	40	160	200
	TC-0459	02.02.0459	Tapa cuadrada para dos interruptores. Two gang two toggles switches cover. Device mount.	4	1.02	.040	3.7	8.2	10	40	160	200
	TC-0510	02.02.0510	Tapa cuadrada para contacto duplex y apagador. Two gang toggle switch and duplex receptaclecover. Box mount.	4	1.02	.040	3.3	7.2	10	40	160	200
	TC-0511	02.02.0511	Tapa cuadrada para contacto duplex y apagador. Two gang toggle switch and duplex receptaclecover. Device mount.	3	1.02	.040	3.3	7.2	10	40	160	200
	TC-0418 ECN-0430	02.02.1311.G	Tapa cuadrada ciega con empaque. Weatherproof two gang blank cover. Box mount with gasket.	4	1.02	.040	3.9	8.6	10	40	120	200
	TC-0458 ECN-0430	02.02.1312.G	Tapa cuadrada ciega con empaque. Weatherproof two gang blank cover. Device mount with gasket.	4	1.02	.040	3.9	8.6	10	40	120	200

Especificaciones sujetas a cambio sin previo aviso. Specifications are subject to change without notice.

RAWELT, S.A. de C.V.

RAWELT INYECTADOS

Una División del Grupo REVUELTA

22 - V - 2009

4.1 - CAJA CUADRADA. A PRUEBA DE INTEMPERIE. SERIE RC.

Hoja: 5 / 6
Page:

4.1 - WEATHERPROOF TWO GANG BOX. RC SERIES.

FICHA TECNICA / TECHNICAL DATA

007-RW-155

USAR No. DE CODIGO PARA HACER PEDIDOS / TO ORDER USE CODE NUMBER

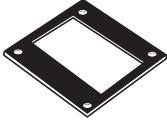
Figura Figure	Catalogo Catalog	Codigo Code	Descripción Description	Cant. Diam. Qty.	Espesor Thickness		Peso x 100 pzas. Weight x 100 pcs.		Pqt. Unit Pzas. Pcs.	Unit Ctn. Pzas. Pcs.	Ship Ctn. Pzas. Pcs.	Std. Pkg. Pzas. Pcs.
					mm	inch	kg	Lb				
	ECN-0430	02.04.0430	Empaque de Neopreno tipo cuadrado. Neoprene gasket.	4	1.6	1/16	1.6	3.5	10	120	480	

TAPON / PLUG

USAR No. DE CODIGO PARA HACER PEDIDOS / TO ORDER USE CODE NUMBER

Figura Figure	Catalogo Catalog	Codigo Code	Descripción Description	Medida nominal Hub size		Peso x 100 pzas. Weight x 100 pcs.		Pqt. Unit Pzas. Pcs.	Unit Ctn. Pzas. Pcs.	Ship Ctn. Pzas. Pcs.	Std. Pkg. Pzas. Pcs.
				mm	inch	kg	Lb				
	TA-0371	01.04.0371	Tapón roscado.	12.7	1/2	1.0	2.2	25	200	2000	
	TA-0368	01.04.0368	Close up plug.	19.0	3/4	1.3	2.9	25	100	1000	

Certificaciones / Compliances:



Expediente/File No. LR 105795-1



Expediente/File No. E135600



Tapones
Closure plugs

Especificaciones sujetas a cambio sin previo aviso. Specifications are subject to change without notice.

RAWELT, S.A. de C.V.



Una División del Grupo **REVUELTA**

16 - VI - 2009

4.1 - CAJA CUADRADA. A PRUEBA DE INTEMPERIE. SERIE RC.

Hoja: 6 / 6
Page:

4.1 - WEATHERPROOF TWO GANG BOXES. RC SERIES.

FICHA TECNICA / TECHNICAL DATA

007-RW-155

TAPA

- Material: Aluminio inyectado a presión (diecast).
- Acabados: Pintura electrostática epoxica/poliester polimerizada.
- Para uso en interiores y exteriores.
- Provee protección contra la intemperie cuando el receptaculo no esta en uso.
- Empaque y tornillos galvanizados incluidos.
- Contratapa con mecanismo de auto-cierre.

COVER

- Diecast aluminum.
- Finish: Electrostatic powder epoxy/poliester coating.
- For use in interiors and exteriors.
- Provides weatherproof protection when the receptacle is not in use.
- Gasket and galvanized mounting screws included.
- Self-closing cover.

USAR No. DE CODIGO PARA HACER PEDIDOS / TO ORDER USE CODE NUMBER

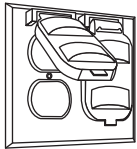
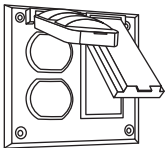
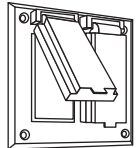
Figura Figure	Catalogo Catalog	Codigo Code	Descripción Description	Cant. Diam. Qty.	Peso x 100 pzas. Weight x 100 pcs.		Pqt. Unit Pzas. Pcs.	Unit Ctn. Pzas. Pcs.	Ship Ctn. Pzas. Pcs.	Std Pkg. Pzas. Pcs.
					kg	Lb				
	TC-0568	02.03.0568	Tapa cuadrada a prueba de intemperie para 2 contactos duplex. Weatherproof two gang cover for 2 duplex receptacles.	2	24.5	54.0	1	8	32	64
	TC-3252	02.03.3252	Tapa cuadrada a prueba de intemperie para 1 contacto duplex y 1 contacto GFCI. Weatherproof two gang cover for 1 duplex receptacle and 1 GFCI receptacle.	4	24.0	53.0	1	8	32	64
	TC-3253	02.03.3253	Tapa cuadrada a prueba de intemperie para 2 contactos GFCI. Weatherproof two gang cover for 2 GFCI receptacles.	4	23.0	51.0	1	8	32	64

Especificaciones sujetas a cambio sin previo aviso. Specifications are subject to change without notice.

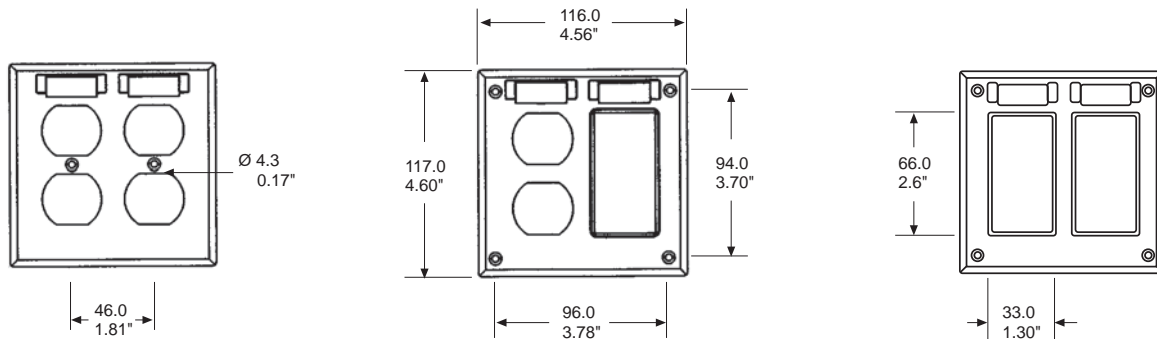

Dimensiones en milímetros y pulgadas. Dimensions in millimeters and inches.

RAWELT, S.A. de C.V.

RAWELT INYECTADOS

Una División del Grupo **REVUELTA**

16 - VI - 2009

Cotización/Quotation Plazo de embarque* / Shipment exw* :

Pedido No./Purchase order :

Our ref.:

Fecha/Date: Vendedor/Salesman: No.

Facturar a/Invoice to: RFC.

Ordenado por/Ordered by: Tel. () Fax ()

Dirección/Address:























C.P./Zip. Lugar/City/Country:

Consignar a/Ship to:

Embarcar: Camión x Cobrar Pagado Paquete

Cond. de Pago/Terms:

Cond. de Venta/Sale conditions: L.P.:

4.1 - SERIE RC. CAJA CUADRADA A PRUEBA DE INTEMPERIE / WEATHERPROOF TWO GANG BOX.														
Figura Figure	Código Code	Medida nominal Hub size		Pqt. Unit. Pzas. Pcs.	Unit. Ctn. Pzas. Pcs.	Ship Ctn. Pzas. Pcs.	Std. Pkg. Pzas. Pcs.	Cantidad Qty.	Figura Figure	Código Code	Medida nominal Hub size		Std. Pkg. Pzas. Pcs.	Cantidad Qty.
		mm	inch								mm	inch		
	02.01.0482	12.7	1/2				24			02.01.0279	12.7	1/2	24	
	02.01.0483	19.0	3/4				24			02.01.0280	19.0	3/4	24	
	02.01.0484	12.7	1/2				24			02.01.0327	12.7	1/2	24	
	02.01.0485	19.0	3/4				24			02.01.0328	19.0	3/4	24	
	02.01.0502	12.7	1/2				24			02.01.0406	12.7	1/2	24	
	02.01.0503	19.0	3/4				24			02.01.0407	19.0	3/4	24	
	02.01.0486	12.7	1/2				24			02.01.0390	12.7	1/2	24	
	02.01.0487	19.0	3/4				24			02.01.0391	19.0	3/4	24	
	02.01.0488	12.7	1/2				24			02.01.0392	12.7	1/2	24	
	02.01.0489	19.0	3/4				24			02.01.0393	19.0	3/4	24	
	02.01.0492	12.7	1/2				24			02.01.0396	12.7	1/2	24	
	02.01.0493	19.0	3/4				24			02.01.0397	19.0	3/4	24	
	02.01.0490	12.7	1/2				24			02.01.0394	12.7	1/2	24	
	02.01.0491	19.0	3/4				24			02.01.0395	19.0	3/4	24	
	02.01.0494	12.7	1/2				24			02.01.0398	12.7	1/2	24	
	02.01.0495	19.0	3/4				24			02.01.0399	19.0	3/4	24	
	02.01.0498	12.7	1/2				24			02.01.0402	12.7	1/2	24	
	02.01.0499	19.0	3/4				24			02.01.0403	19.0	3/4	24	
	02.01.0496	12.7	1/2				24			02.01.0400	12.7	1/2	24	
	02.01.0497	19.0	3/4				24			02.01.0401	19.0	3/4	24	
	02.01.0500	12.7	1/2				24			02.01.0404	12.7	1/2	24	
	02.01.0501	19.0	3/4				24			02.01.0405	19.0	3/4	24	
	01.04.0371	12.7	1/2	25	200	2000								
	01.04.0368	19.0	3/4	25	100	1000								

Expediente
 Control
 Embarques
 Almacén
 Producción

- Antes de fincar el pedido en firme, favor de confirmar con fábrica el plazo de embarque definitivo.
- Before place your order, please confirm with RAWELT definitive date of shipment.

Cotización/Quotation Plazo de embarque* / Shipment exw* :

 Pedido No./Purchase order : _____

Our ref.: _____

Fecha/Date: _____ Vendedor/Salesman: _____ No. _____

Facturar a/Invoice to: _____ RFC: _____

Ordenado por/Ordered by: _____ Tel. () _____ Fax () _____

Dirección/Address: _____







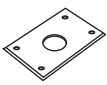
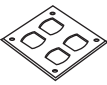
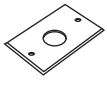
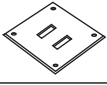
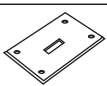
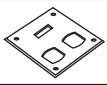
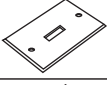
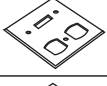
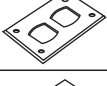

C.P./Zip: _____ Lugar/City/Country: _____

Consignar a/Ship to: _____

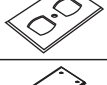
 Embarcar: Camión x Cobrar Pagado Paquete

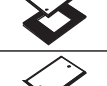
Cond. de Pago/Terms: _____

Cond. de Venta/Sale conditions: _____ L.P.: _____

3. - SERIE RR. TAPA Y EMPAQUE / COVER AND GASKET.							4. - SERIE RC. TAPA Y EMPAQUE/COVER AND GASKET.							<input type="checkbox"/> Expediente <input type="checkbox"/> Control <input type="checkbox"/> Embarques <input type="checkbox"/> Almacén <input type="checkbox"/> Producción
Figura Figure	Código Code	Diametro Ø	Pqt. Unit. Pzas. Pcs.	Unit. Ctn. Pzas. Pcs.	Ship. Ctn. Pzas. Pcs.	Std. Pkg. Pzas. Pcs.	Cantidad Qty.	Figura Figure	Código Code	Pqt. Unit. Pzas. Pcs.	Unit. Ctn. Pzas. Pcs.	Ship. Ctn. Pzas. Pcs.	Std. Pkg. Pzas. Pcs.	
	01.02.0424	Ø 35.23 mm	10	50	200	400			02.02.0417	10	40	160	200	
	01.02.0414	Ø 40.38 mm	10	50	200	400			02.02.0457	10	40	160	200	
	01.02.0426	Ø 54.30 mm	10	50	200	400			02.02.0419	10	40	160	200	
	01.02.0425	Ø 35.23 mm	10	50	200	400			02.02.0459	10	40	160	200	
	01.02.0423	Ø 40.38 mm	10	50	200	400			02.02.0510	10	40	160	200	
	01.02.0427	Ø 54.30 mm	10	50	200	400			02.02.0511	10	40	160	200	
	01.02.0415		10	50	200	400			02.02.0510	10	40	160	200	
	01.02.0421		10	50	200	400			02.02.0511	10	40	160	200	
	01.02.0385		10	50	200	400			02.02.1311.G	10	40	120	200	
	01.02.0422		10	50	200	400			02.02.1312.G	10	40	120	200	
	01.02.1309.G		10	40	160	330			02.04.0430 1/16	10	120	480		
	01.02.1310.G		10	40	160	330								
	01.05.0429 1/16		10	100	700									

- Antes de fincar el pedido en firme, favor de confirmar con fábrica el plazo de embarque definitivo.
- Before place your order, please confirm with RAWELT definitive date of shipment.

Cotización/Quotation Plazo de embarque* / Shipment exw* :

 Pedido No./Purchase order :

Our ref.:

Fecha/Date: Vendedor/Salesman: No.

Facturar a/Invoice to: RFC:

Ordenado por/Ordered by: Tel. () Fax ()

Dirección/Address:







C.P./Zip: Lugar/City/Country:

Consignar a/Ship to:

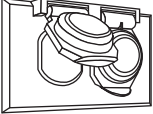
 Embarcar: Camión x Cobrar Pagado Paquete

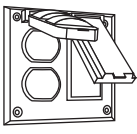
Cond. de Pago/Terms:

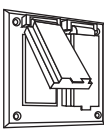
Cond. de Venta/Sale conditions: L.P.:

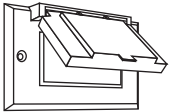
3.- SERIE RR. TAPA A PRUEBA DE INTEMPERIE/WEATHERPROOF COVER.						4.- SERIE RC. TAPA A PRUEBA DE INTEMPERIE/WEATHERPROOF COVER.							
Figura Figure	Código Code	Pqt. Unit. Pzas. Pcs.	Unit. Ctn. Pzas. Pcs.	Ship. Ctn. Pzas. Pcs.	Std. Pkg. Pzas. Pcs.	Cantidad Qty.	Figura Figure	Código Code	Pqt. Unit. Pzas. Pcs.	Unit. Ctn. Pzas. Pcs.	Ship. Ctn. Pzas. Pcs.	Std. Pkg. Pzas. Pcs.	Cantidad Qty.
	01.03.0611	1	12	48	96			02.03.0568	1	8	32	64	
	01.03.0567	1	12	48	96			02.03.3252	1	8	32	64	
	01.03.0563	1	12	48	96			02.03.3253	1	8	32	64	
	01.03.0565	1	12	48	96								
	01.03.3251	1	12	48	96								

 Expediente
 Control
 Embarques
 Almacén
 Producción

- Antes de fincar el pedido en firme, favor de confirmar con fábrica el plazo de embarque definitivo.
- Before place your order, please confirm with RAWELT definitive date of shipment.

**TABLA DE EQUIVALENCIAS.
CROSS REFERENCE GUIDE.**

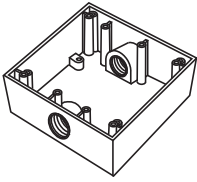
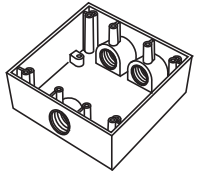
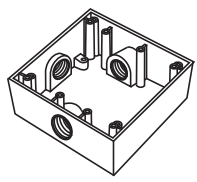
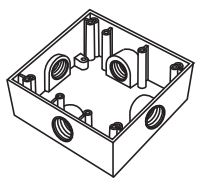
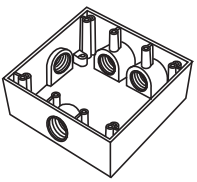
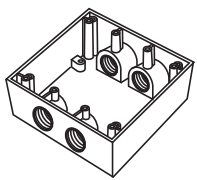
	2 ENTRADAS / 2 HUBS				
	Medida Nominal Size	RAWELT		PERFECT LINE	BWF
		Código Code	Catalogo Catalog	Catalogo Catalog	Catalogo Catalog
	1/2	Sin orejas	02.01.0482	RC-0482	
	3/4	W/out lugs	02.01.0483	RC-0483	
	1/2	Con orejas	02.01.0482.M	RC-0482-M	
3/4	With lugs	02.01.0483.M	RC-0485-M		
	3 ENTRADAS / 3 HUBS				
	Medida Nominal Size	RAWELT		PERFECT LINE	BWF
		Código Code	Catalogo Catalog	Catalogo Catalog	Catalogo Catalog
	1/2	Sin orejas	02.01.0484	RC-0484	
	3/4	W/out lugs	02.01.0485	RC-0485	
	1/2	Con orejas	02.01.0484.M	RC-0484-M	
3/4	With lugs	02.01.0485.M	RC-0485-M		
	3 ENTRADAS / 3 HUBS				
	Medida Nominal Size	RAWELT		PERFECT LINE	BWF
		Código Code	Catalogo Catalog	Catalogo Catalog	Catalogo Catalog
	1/2	Sin orejas	02.01.0502	RC-0502	
	3/4	W/out lugs	02.01.0503	RC-0503	
	1/2	Con orejas	02.01.0502.M	RC-0502-M	
3/4	With lugs	02.01.0503.M	RC-0503-M		
	3 ENTRADAS / 3 HUBS				
	Medida Nominal Size	RAWELT		PERFECT LINE	BWF
		Código Code	Catalogo Catalog	Catalogo Catalog	Catalogo Catalog
	1/2	Sin orejas	02.01.0486	RC-0486	
	3/4	W/out lugs	02.01.0487	RC-0487	
	1/2	Con orejas	02.01.0486.M	RC-0486-M	
3/4	With lugs	02.01.0487.M	RC-0487-M		
	4 ENTRADAS / 4 HUBS				
	Medida Nominal Size	RAWELT		PERFECT LINE	BWF
		Código Code	Catalogo Catalog	Catalogo Catalog	Catalogo Catalog
	1/2	Sin orejas	02.01.0488	RC-0488	
	3/4	W/out lugs	02.01.0489	RC-0489	
	1/2	Con orejas	02.01.0488.M	RC-0488-M	
3/4	With lugs	02.01.0489.M	RC-0489-M		
	4 ENTRADAS / 4 HUBS				
	Medida Nominal Size	RAWELT		PERFECT LINE	BWF
		Código Code	Catalogo Catalog	Catalogo Catalog	Catalogo Catalog
	1/2	Sin orejas	02.01.0492	RC-0492	
	3/4	W/out lugs	02.01.0493	RC-0493	
	1/2	Con orejas	02.01.0492.M	RC-0492-M	
3/4	With lugs	02.01.0493.M	RC-0493-M		

RAWELT, S.A. de C.V.



Una División del Grupo REVUELTA

**TABLA DE EQUIVALENCIAS.
CROSS REFERENCE GUIDE.**

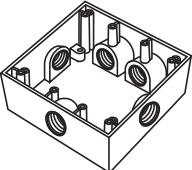
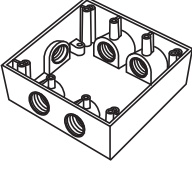
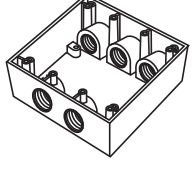
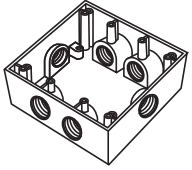
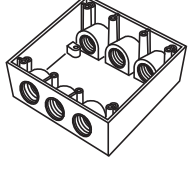
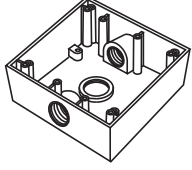
	5 ENTRADAS / 5 HUBS					
	Medida Nominal Size	RAWELT		PERFECT LINE	BWF	
		Código Code	Catalogo Catalog	Catalogo Catalog	Catalogo Catalog	
	1/2	Sin orejas	02.01.0490	RC-0490		
	3/4	W/out lugs	02.01.0491	RC-0491		
1/2	Con orejas	02.01.0490.M	RC-0490-M			
3/4	With lugs	02.01.0491.M	RC-0491-M			
	5 ENTRADAS / 5 HUBS					
	Medida Nominal Size	RAWELT		PERFECT LINE	BWF	
		Código Code	Catalogo Catalog	Catalogo Catalog	Catalogo Catalog	
	1/2	Sin orejas	02.01.0494	RC-0494		
	3/4	W/out lugs	02.01.0495	RC-0495		
1/2	Con orejas	02.01.0494.M	RC-0494-M			
3/4	With lugs	02.01.0495.M	RC-0495-M			
	5 ENTRADAS / 5 HUBS					
	Medida Nominal Size	RAWELT		PERFECT LINE	BWF	
		Código Code	Catalogo Catalog	Catalogo Catalog	Catalogo Catalog	
	1/2	Sin orejas	02.01.0498	RC-0498		
	3/4	W/out lugs	02.01.0499	RC-0499		
1/2	Con orejas	02.01.0498.M	RC-0498-M			
3/4	With lugs	02.01.0499.M	RC-0499-M			
	6 ENTRADAS / 6 HUBS					
	Medida Nominal Size	RAWELT		PERFECT LINE	BWF	
		Código Code	Catalogo Catalog	Catalogo Catalog	Catalogo Catalog	
	1/2	Sin orejas	02.01.0496	RC-0496		
	3/4	W/out lugs	02.01.0497	RC-0497		
1/2	Con orejas	02.01.0496.M	RC-0496-M			
3/4	With lugs	02.01.0497.M	RC-0497-M			
	6 ENTRADAS / 6 HUBS					
	Medida Nominal Size	RAWELT		PERFECT LINE	BWF	
		Código Code	Catalogo Catalog	Catalogo Catalog	Catalogo Catalog	
	1/2	Sin orejas	02.01.0500	RC-0500		
	3/4	W/out lugs	02.01.0501	RC-0501		
1/2	Con orejas	02.01.0500.M	RC-0500-M			
3/4	With lugs	02.01.0501.M	RC-0501-M			
	3 ENTRADAS / 3 HUBS					
	Medida Nominal Size	RAWELT		PERFECT LINE	BWF	
		Código Code	Catalogo Catalog	Catalogo Catalog	Catalogo Catalog	
	1/2	Sin orejas	02.01.0279	RC-0279	LT11	TGB-5
	3/4	W/out lugs	02.01.0280	RC-0280	LT14	TGB-75
1/2	Con orejas	02.01.0279.M	RC-0279-M	LT11-L	TGB-5L	
3/4	With lugs	02.01.0280.M	RC-0280-M	LT14-L	TGB-75L	

RAWELT, S.A. de C.V.

 Una División del Grupo **REVUELTA**

**TABLA DE EQUIVALENCIAS.
CROSS REFERENCE GUIDE.**

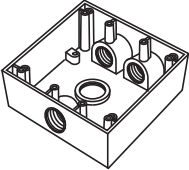
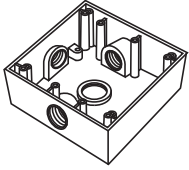
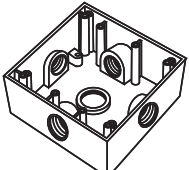
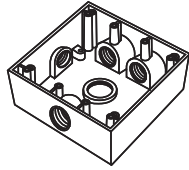
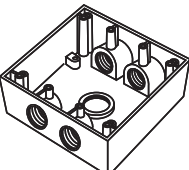
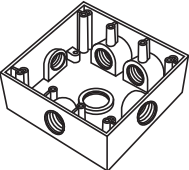
	4 ENTRADAS / 4 HUBS					
	Medida Nominal Size	RAWELT		PERFECT LINE	BWF	
		Código Code	Catalogo Catalog	Catalogo Catalog	Catalogo Catalog	
	1/2	Sin orejas	02.01.0327	RC-0327	LT11-2	TGB-54
	3/4	W/out lugs	02.01.0328	RC-0328	LT14-2	TGB-75-4
	1/2	Con orejas	02.01.0327.M	RC-0327-M	LT11-2L	TGB-5L
3/4	With lugs	02.01.0328.M	RC-0328-M	LT14-2L	TGB-75L	
	4 ENTRADAS / 4 HUBS					
	Medida Nominal Size	RAWELT		PERFECT LINE	BWF	
		Código Code	Catalogo Catalog	Catalogo Catalog	Catalogo Catalog	
	1/2	Sin orejas	02.01.0406	RC-0406		
	3/4	W/out lugs	02.01.0407	RC-0407		
	1/2	Con orejas	02.01.0406.M	RC-0406-M		
3/4	With lugs	02.01.0407.M	RC-0407-M			
	5 ENTRADAS / 5 HUBS					
	Medida Nominal Size	RAWELT		PERFECT LINE	BWF	
		Código Code	Catalogo Catalog	Catalogo Catalog	Catalogo Catalog	
	1/2	Sin orejas	02.01.0390	RC-0390	LTX11-5	TGB-55X
	3/4	W/out lugs	02.01.0391	RC-0391	LTX14-5	TGB-75-5X
	1/2	Con orejas	02.01.0390.M	RC-0390-M	LTX11-5L	TGB-55XL
3/4	With lugs	02.01.0391.M	RC-0391-M	LTX14-5L	TGB-75-5XL	
	5 ENTRADAS / 5 HUBS					
	Medida Nominal Size	RAWELT		PERFECT LINE	BWF	
		Código Code	Catalogo Catalog	Catalogo Catalog	Catalogo Catalog	
	1/2	Sin orejas	02.01.0392	RC-0392		
	3/4	W/out lugs	02.01.0393	RC-0393		
	1/2	Con orejas	02.01.0392.M	RC-0392-M		
3/4	With lugs	02.01.0393.M	RC-0393-M			
	5 ENTRADAS / 5 HUBS					
	Medida Nominal Size	RAWELT		PERFECT LINE	BWF	
		Código Code	Catalogo Catalog	Catalogo Catalog	Catalogo Catalog	
	1/2	Sin orejas	02.01.0396	RC-0396	LT11-3	TGB-55L
	3/4	W/out lugs	02.01.0397	RC-0397	LT14-3	TGB-75-5
	1/2	Con orejas	02.01.0396.M	RC-0396-M	LT11-3L	TGB-55L
3/4	With lugs	02.01.0397.M	RC-0397-M	LT14-3L	TGB-75-5L	
	6 ENTRADAS / 6 HUBS					
	Medida Nominal Size	RAWELT		PERFECT LINE	BWF	
		Código Code	Catalogo Catalog	Catalogo Catalog	Catalogo Catalog	
	1/2	Sin orejas	02.01.0394	RC-0394	LTX11-6	
	3/4	W/out lugs	02.01.0395	RC-0395	LTX14-6	
	1/2	Con orejas	02.01.0394.M	RC-0394-M	LTX11-6L	TGB-56XL
3/4	With lugs	02.01.0395.M	RC-0395-M	LTX14-6L	TGB-75-6XL	

RAWELT, S.A. de C.V.

 **RAWELT**® INYECTADOS

Una División del Grupo  **REVUELTA**

TABLA DE EQUIVALENCIAS.
CROSS REFERENCE GUIDE.

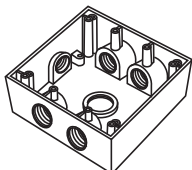
	6 ENTRADAS / 6 HUBS				
	Medida Nominal Size	RAWELT		PERFECT LINE	BWF
		Código Code	Catalogo Catalog	Catalogo Catalog	Catalogo Catalog
1/2	Sin orejas	02.01.0398	RC-0398		
3/4	W/out lugs	02.01.0399	RC-0399		
1/2	Con orejas	02.01.0398.M	RC-0398-M		
3/4	With lugs	02.01.0399.M	RC-0399-M		

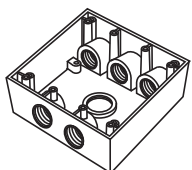
	6 ENTRADAS / 6 HUBS				
	Medida Nominal Size	RAWELT		PERFECT LINE	BWF
		Código Code	Catalogo Catalog	Catalogo Catalog	Catalogo Catalog
1/2	Sin orejas	02.01.0402	RC-0402		
3/4	W/out lugs	02.01.0403	RC-0403		
1/2	Con orejas	02.01.0402.M	RC-0402-M		
3/4	With lugs	02.01.0403.M	RC-0403-M		

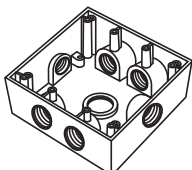
	7 ENTRADAS / 7 HUBS				
	Medida Nominal Size	RAWELT		PERFECT LINE	BWF
		Código Code	Catalogo Catalog	Catalogo Catalog	Catalogo Catalog
1/2	Sin orejas	02.01.0400	RC-0400	LTX11-7	
3/4	W/out lugs	02.01.0401	RC-0401	LTX14-7	
1/2	Con orejas	02.01.0400.M	RC-0400-M	LTX11-7L	
3/4	With lugs	02.01.0401.M	RC-0401-M	LTX14-7L	

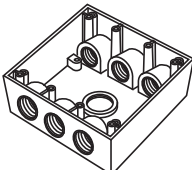
	7 ENTRADAS / 7 HUBS				
	Medida Nominal Size	RAWELT		PERFECT LINE	BWF
		Código Code	Catalogo Catalog	Catalogo Catalog	Catalogo Catalog
1/2	Sin orejas	02.01.0404	RC-0404	LT11-33	TGB-57
3/4	W/out lugs	02.01.0405	RC-0405	LT14-33	TGB-77
1/2	Con orejas	02.01.0404.M	RC-0404-M	LT11-33L	TGB-57L
3/4	With lugs	02.01.0405.M	RC-0405-M	LT14-33L	TGB-77L

Rawelt, S.A. de C.V. no asume ninguna responsabilidad por omisiones, errores, diferencias, en el diseño o función entre los productos arriba mencionados.

Rawelt, S.A. de C.V. assumes no liability for omission, errors, differences between bodies above mentioned or change in design or function.

RAWELT, S.A. de C.V.



Una División del Grupo **REVUELTA**

2 - I - 2001

**4.2 - CAJA CUADRADA. A PRUEBA DE INTEMPERIE. SERIE RC.
CON OREJAS PARA MONTAJE.**

**4.2 - WEATHERPROOF TWO GANG BOX. RC SERIES.
WITH MOUNTING LUGS.**

Dimensiones en milímetros y en pulgadas.
Dimensions in inches and millimeters.



LISTED
1M70



- Material: Aluminio inyectado a presión (diecast).
- Acabados: Pintura electrostática epoxica/poliester polimerizada.
- Dos tornillos de tierra pasivados incluidos.
- Dos orejas para montaje, tornillos y tapones incluidos.
- A prueba de intemperie cuando se usa tapa con empaque.
- Rosca NPT para usarse con tubo conduit RIGIDO e IMC.

APLICACIONES:

- Pueden ser instaladas para recibir accesorios como: Interruptores, contactos, estaciones de botones, luces piloto.
- Sirven para hacer empalmes y conexiones en el cableado. Permite facil acceso para mantenimiento.
- Fabricación en base a: UL 514 A, UL 514 B
CAN/CSA-C22.2 No. 18-92

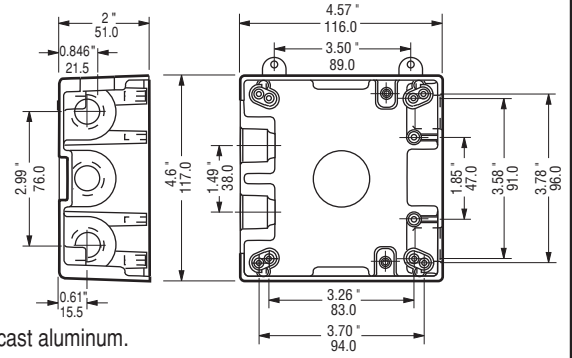

- Material: Diecast aluminum.
- Finish: Electrostatic powder epoxy/poliester coating.
- Two green ground screws included.
- Two mounting lugs, screws and close-up plugs included.
- For wet location when gasketed cover are used.
- NPT threaded for use with RIGID and IMC conduit.

APPLICATIONS:

- They can be installed to accommodate accessories such as switches, receptacles.
- Provide openings for making splice and taps. Allow access for maintenance.
- Manufactured in compliance with: UL 514 A, UL 514 B
CAN/CSA-C22.2 No. 18-92

USAR No. DE CODIGO PARA HACER PEDIDOS / TO ORDER USE CODE NUMBER

Figura Figure	Bocas Hubs	Catalogo Catalog	Codigo Code	Medida nominal Hub size		Volumen Volume		Peso x 100 pzas. Weight x 100 pcs.		Pqt. Unit. Pzas. Pcs.	Std. Pkg. Pzas. Pcs.	
				mm	inch.	cm ³	cu. in	kg	Lb			
	Arriba/Top	1	RC-0482-M	02.01.0482.M	12.7	1/2	492.0	30.0	42.5	93.6	1	24
	Abajo/Bottom	1	RC-0483-M	02.01.0483.M	19.0	3/4	492.0	30.0	41.0	90.3	1	24
	Arriba/Top	2	RC-0484-M	02.01.0484.M	12.7	1/2	483.8	29.5	42.5	93.6	1	24
	Abajo/Bottom	1	RC-0485-M	02.01.0485.M	19.0	3/4	483.8	29.5	39.0	85.9	1	24
	Arriba/Top	1	RC-0502-M	02.01.0502.M	12.7	1/2	492.0	30.0	42.0	92.5	1	24
	Abajo/Bottom	1	RC-0503-M	02.01.0503.M	19.0	3/4	492.0	30.0	39.5	87.0	1	24
	Izquierda/Left	1	RC-0503-M	02.01.0503.M	19.0	3/4	492.0	30.0	39.5	87.0	1	24
	Arriba/Top	1	RC-0486-M	02.01.0486.M	12.7	1/2	492.0	30.0	41.5	91.4	1	24
	Abajo/Bottom	1	RC-0487-M	02.01.0487.M	19.0	3/4	492.0	30.0	39.0	85.9	1	24
	Izquierda/Left	1	RC-0487-M	02.01.0487.M	19.0	3/4	492.0	30.0	39.0	85.9	1	24
	Derecha/Right	1	RC-0487-M	02.01.0487.M	19.0	3/4	492.0	30.0	39.0	85.9	1	24
	Arriba/Top	2	RC-0488-M	02.01.0488.M	12.7	1/2	475.0	29.5	48.38	91.4	1	24
	Abajo/Bottom	1	RC-0489-M	02.01.0489.M	19.0	3/4	475.0	29.5	48.38	83.7	1	24
	Izquierda/Left	1	RC-0489-M	02.01.0489.M	19.0	3/4	475.0	29.5	48.38	83.7	1	24

Especificaciones sujetas a cambio sin previo aviso. Specifications are subject to change without notice.

RAWELT, S.A. de C.V.



Una División del Grupo REVUELTA

**4.2 - CAJA CUADRADA. A PRUEBA DE INTEMPERIE. SERIE RC.
CON OREJAS PARA MONTAJE.**

**4.2 - WEATHERPROOF TWO GANG BOX. RC SERIES.
WITH MOUNTING LUGS.**

Hoja: 2 / 6
Page:

FICHA TECNICA / TECHNICAL DATA

007-RW-172

USAR No. DE CODIGO PARA HACER PEDIDOS / TO ORDER USE CODE NUMBER

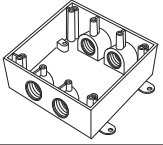
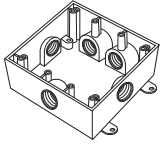
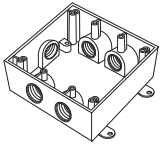
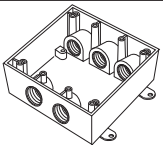
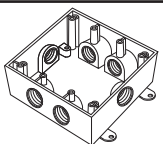
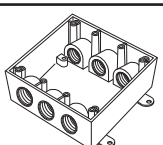
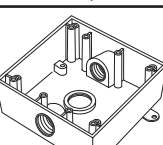
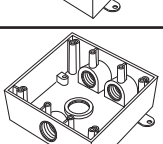
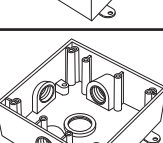
Figura Figure	Bocas Hubs	Catalogo Catalog	Codigo Code	Medida nominal Hub size		Volumen Volume		Peso x 100 pzas. Weight x 100 pcs.		Pqt. Unit. Pzas. Pcs.	Std. Pkg. Pzas. Pcs.
				mm	inch.	cm ³	cu. in	kg	Lb		
	Arriba/Top 2	RC-0492-M	02.01.0492.M	12.7	1/2	480.5	29.3	43.0	94.7	1	24
	Abajo/Bottom 2	RC-0493-M	02.01.0493.M	19.0	3/4	480.5	29.3	38.0	83.7	1	24
	Arriba/Top 2	RC-0490-M	02.01.0490.M	12.7	1/2	483.8	29.5	41.0	90.3	1	24
	Abajo/Bottom 1	RC-0491-M	02.01.0491.M	19.0	3/4	483.8	29.5	37.0	81.5	1	24
	Izquierda/Left 1										
	Arriba/Top 2	RC-0494-M	02.01.0494.M	12.7	1/2	480.5	29.3	42.0	92.5	1	24
	Abajo/Bottom 2	RC-0495-M	02.01.0495.M	19.0	3/4	480.5	29.3	37.0	81.5	1	24
	Izquierda/Left 1										
	Arriba/Top 3	RC-0498-M	02.01.0498.M	12.7	1/2	475.6	29.0	44.5	98.1	1	24
	Abajo/Bottom 2	RC-0499-M	02.01.0499.M	19.0	3/4	475.6	29.0	39.5	87.0	1	24
	Arriba/Top 2	RC-0496-M	02.01.0496.M	12.7	1/2	480.5	29.3	41.5	91.4	1	24
	Abajo/Bottom 2	RC-0497-M	02.01.0497.M	19.0	3/4	480.5	29.3	36.0	79.3	1	24
	Izquierda/Left 1										
	Arriba/Top 3	RC-0500-M	02.01.0500.M	12.7	1/2	472.3	28.8	45.0	99.2	1	24
	Abajo/Bottom 3	RC-0501-M	02.01.0501.M	19.0	3/4	472.3	28.8	38.5	84.8	1	24
	Arriba/Top 1	RC-0279-M	02.01.0279.M	12.7	1/2	492.0	30.0	42.0	92.5	1	24
	Abajo/Bottom 1	RC-0280-M	02.01.0280.M	19.0	3/4	492.0	30.0	40.5	89.2	1	24
	Detrás/Back 1										
	Arriba/Top 2	RC-0327-M	02.01.0327.M	12.7	1/2	483.8	29.5	42.0	92.5	1	24
	Abajo/Bottom 1	RC-0328-M	02.01.0328.M	19.0	3/4	483.8	29.5	38.5	84.8	1	24
	Detrás/Back 1										
	Arriba/Top 1	RC-0406-M	02.01.0406.M	12.7	1/2	492.0	30.0	41.5	91.4	1	24
	Abajo/Bottom 1	RC-0407-M	02.01.0407.M	19.0	3/4	492.0	30.0	39.0	85.9	1	24
	Izquierda/Left 1										
	Detrás/Back 1										

Especificaciones sujetas a cambio sin previo aviso. Specifications are subject to change without notice.

RAWELT, S.A. de C.V.



Una División del Grupo REVUELTA

22 - V - 2009

**4.2 - CAJA CUADRADA. A PRUEBA DE INTEMPERIE. SERIE RC.
CON OREJAS PARA MONTAJE.**



**4.2 - WEATHERPROOF TWO GANG BOX. RC SERIES.
WITH MOUNTING LUGS.**

Hoja: 3 / 6
Page:

FICHA TECNICA / TECHNICAL DATA

007-RW-172

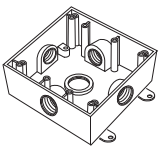
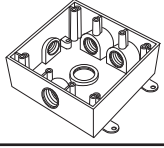
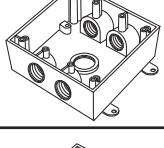
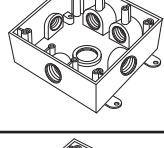
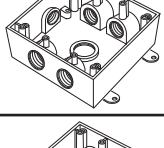
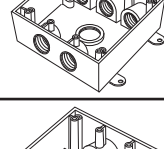
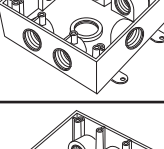
USAR No. DE CODIGO PARA HACER PEDIDOS / TO ORDER USE CODE NUMBER

Figura Figure	Bocas Hubs	Catalogo Catalog	Codigo Code	Medida nominal Hub size		Volumen Volume		Peso x 100 pzas. Weight x 100 pcs.		Pqt. Unit. Pzas. Pcs.	Std. Pkg. Pzas. Pcs.	
				mm	inch.	cm ³	cu. in	kg	Lb			
	Arriba/Top	1	RC-0390-M	02.01.0390.M	12.7	1/2	492.0	30.0	41.0	90.3	1	24
	Abajo/Bottom	1										
	Izquierda/Left	1	RC-0391-M	02.01.0391.M	19.0	3/4	492.0	30.0	38.5	84.8	1	24
	Derecha/Right	1										
Detrás/Back	1											
	Arriba/Top	2	RC-0392-M	02.01.0392.M	12.7	1/2	483.8	29.5	41.0	90.3	1	24
	Abajo/Bottom	1										
	Izquierda/Left	1	RC-0393-M	02.01.0393.M	19.0	3/4	483.8	29.5	37.5	82.6	1	24
	Detrás/Back	1										
	Arriba/Top	2	RC-0396-M	02.01.0396.M	12.7	1/2	480.5	29.3	42.5	93.6	1	24
	Abajo/Bottom	2										
	Detrás/Back	1	RC-0397-M	02.01.0397.M	19.0	3/4	480.5	29.3	37.5	82.6	1	24
	Arriba/Top	2	RC-0394-M	02.01.0394.M	12.7	1/2	483.8	29.5	40.5	89.2	1	24
	Abajo/Bottom	1										
	Izquierda/Left	1	RC-0395-M	02.01.0395.M	19.0	3/4	483.8	29.5	36.5	80.4	1	24
	Derecha/Right	1										
Detrás/Back	1											
	Arriba/Top	2	RC-0398-M	02.01.0398.M	12.7	1/2	480.5	29.3	41.5	91.4	1	24
	Abajo/Bottom	2										
	Izquierda/Left	1	RC-0399-M	02.01.0399.M	19.0	3/4	480.5	29.3	36.5	80.4	1	24
	Detrás/Back	1										
	Arriba/Top	3	RC-0402-M	02.01.0402.M	12.7	1/2	475.6	29.0	44.0	97.0	1	24
	Abajo/Bottom	2										
	Detrás/Back	1	RC-0403-M	02.01.0403.M	19.0	3/4	475.6	29.0	39.0	85.9	1	24
	Arriba/Top	2	RC-0400-M	02.01.0400.M	12.7	1/2	480.5	29.3	41.0	90.3	1	24
	Abajo/Bottom	2										
	Izquierda/Left	1	RC-0401-M	02.01.0401.M	19.0	3/4	480.5	29.3	35.5	78.2	1	24
	Derecha/Right	1										
Detrás/Back	1											
	Arriba/Top	3	RC-0404-M	02.01.0404.M	12.7	1/2	472.3	28.8	44.5	98.1	1	24
	Abajo/Bottom	3										
	Detrás/Back	1	RC-0405-M	02.01.0405.M	19.0	3/4	472.3	28.8	38.0	83.7	1	24

Certificaciones / Compliances:  Expediente/File No. LR 105795-1  Expediente/File No. E135600

Especificaciones sujetas a cambio sin previo aviso. Specifications are subject to change without notice..

RAWELT, S.A. de C.V.

 **RAWELT**® INYECTADOS
Una División del Grupo  **REVUELTA**

16 - VI - 2009

**4.2 - CAJA CUADRADA. A PRUEBA DE INTEMPERIE. SERIE RC.
CON OREJAS PARA MONTAJE.**

**4.2 - WEATHERPROOF TWO GANG BOX. RC SERIES.
WITH MOUNTING LUGS.**

Hoja: 4 / 6
Page:

FICHA TECNICA / TECHNICAL DATA

007-RW-172

TAPA

- Lámina de aluminio troquelada.
- Uso en interiores.
- Tornillos galvanizados incluidos.

EMPAQUE

- Neopreno

TAPON

- Aluminio inyectado a presión (diecast).

COVER

- Sheet aluminum.
- For use indoors.
- Galvanized mounting screws included.

GASKET

- Neoprene.

CLOSE UP PLUG

- Die cast aluminum.

Dimensiones en milímetros y pulgadas. 155
Dimensions in inches and millimeters. 199

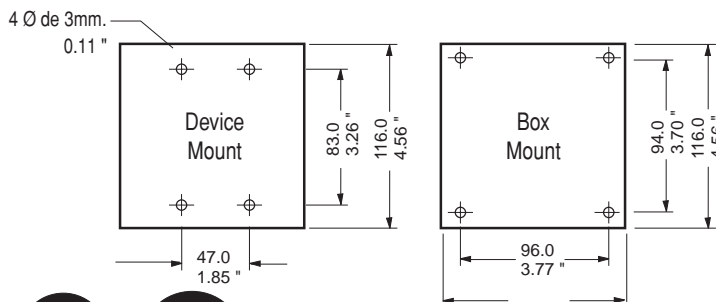

USAR No. DE CODIGO PARA HACER PEDIDOS / TO ORDER USE CODE NUMBER

Figura Figure	Catalogo Catalog	Codigo Code	Descripción Description	Cant. Diam. Qty.	Espesor Thickness		Peso x 100 pzas. Weight x 100 pcs.		Pqt. Unit Pzas. Pcs.	Unit Ctn. Pzas. Pcs.	Ship Ctn. Pzas. Pcs.	Std. Pkg. Pzas. Pcs.
					mm	inch	kg	Lb				
	TC-0417	02.02.0417	Tapa cuadrada para dos contactos duplex. Two gang two duplex receptacles cover. Box mount.	4	1.02	.040	2.9	6.4	10	40	160	200
	TC-0457	02.02.0457	Tapa cuadrada para dos contactos duplex. Two gang two duplex receptacles cover. Device mount.	2	1.02	.040	3.0	6.6	10	40	160	200
	TC-0419	02.02.0419	Tapa cuadrada para dos interruptores. Two gang two toggles switches cover. Box mount.	4	1.02	.040	3.7	8.2	10	40	160	200
	TC-0459	02.02.0459	Tapa cuadrada para dos interruptores. Two gang two toggles switches cover. Device mount.	4	1.02	.040	3.7	8.2	10	40	160	200
	TC-0510	02.02.0510	Tapa cuadrada para contacto duplex y apagador. Two gang toggle switch and duplex receptaclecover. Box mount.	4	1.02	.040	3.3	7.2	10	40	160	200
	TC-0511	02.02.0511	Tapa cuadrada para contacto duplex y apagador. Two gang toggle switch and duplex receptaclecover. Device mount.	3	1.02	.040	3.3	7.2	10	40	160	200
	TC-0418	02.02.1311.G	Tapa cuadrada ciega con empaque. Weatherproof two gang blank cover. Box mount with gasket.	4	1.02	.040	3.9	8.6	10	40	120	200
	ECN-0430											
	TC-0458	02.02.1312.G	Tapa cuadrada ciega con empaque. Weatherproof two gang blank cover. Device mount with gasket.	4	1.02	.040	3.9	8.6	10	40	120	200
	ECN-0430											

Especificaciones sujetas a cambio sin previo aviso. Specifications are subject to change without notice..

RAWELT, S.A. de C.V.



16 - VI - 2009

**4.2 - CAJA CUADRADA. A PRUEBA DE INTEMPERIE. SERIE RC.
CON OREJAS PARA MONTAJE.**

Hoja: 5 / 6
Page:

**4.2 - WEATHERPROOF TWO GANG BOX. RC SERIES.
WITH MOUNTING LUGS.**

FICHA TECNICA / TECHNICAL DATA

007-RW-172

USAR No. DE CODIGO PARA HACER PEDIDOS / TO ORDER USE CODE NUMBER

Figura Figure	Catalogo Catalog	Codigo Code	Descripción Description	Cant. Diam. Qty.	Espesor Thickness		Peso x 100 pzas. Weight x 100 pcs.		Pqt. Unit Pzas. Pcs.	Unit Ctn. Pzas. Pcs.	Ship Ctn. Pzas. Pcs.
					mm.	inch	Kg	Lb			
	ECN-0430	02.04.0430	Empaque de Neopreno tipo cuadrado. Neoprene gasket.	4	1.6	1/16	1.6	3.5	10	120	480

TAPONES / PLUGS

USAR No. DE CODIGO PARA HACER PEDIDOS / TO ORDER USE CODE NUMBER

Figura Figure	Catalogo Catalog	Codigo Code	Descripción Description	Medida nominal Hub size		Peso x 100 pzas. Weight x 100 pcs.		Pqt. Unit Pzas. Pcs.	Unit Ctn. Pzas. Pcs.	Ship Ctn. Pzas. Pcs.
				mm	inch.	kg	Lb			
	TA-0371	01.04.0371	Tapón roscado	12.7	1/2	1.0	2.2	25	200	2000
	TA-0368	01.04.0368	Close-up plug.	19.0	3/4	1.3	2.9	25	100	1000

Certificaciones / Compliances:



Expediente/File No. LR 105795-1



Expediente/File No. E135600

Especificaciones sujetas a cambio sin previo aviso. Specifications are subject to change without notice..

RAWELT, S.A. de C.V.



Una División del Grupo REVUELTA

22 - V - 2009

**4.2 - CAJA CUADRADA. A PRUEBA DE INTEMPERIE. SERIE RC.
CON OREJAS PARA MONTAJE.**

Hoja: 6 / 6
Page:

**4.2 - WEATHERPROOF TWO GANG BOX. RC SERIES.
WITH MOUNTING LUGS.**

FICHA TECNICA / TECHNICAL DATA

007-RW-172

TAPA

- Material: Aluminio inyectado a presión (diecast).
- Acabados: Pintura electrostática epoxica/poliester polimerizada.
- Para uso en interiores y exteriores.
- Provee protección contra la intemperie cuando el receptaculo no esta en uso.
- Empaque y tornillos galvanizados incluidos.
- Contratapa con mecanismo de auto-cierre.

COVER

- Diecast aluminum.
- Finish: Electrostatic powder epoxy/poliester coating.
- For use indoors and outdoors.
- Provides weatherproof protection when the receptacle is not in use.
- Gasket and galvanized mounting screws included.
- Self-closing cover.

USAR No. DE CODIGO PARA HACER PEDIDOS / TO ORDER USE CODE NUMBER

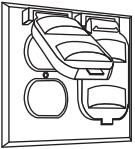
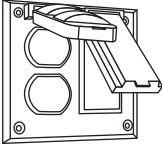
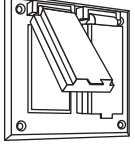
Figura Figure	Catalogo Catalog	Codigo Code	Descripción Description	Cant. Diam. Qty.	Peso x 100 pzas. Weight x 100 pcs.		Pqt. Unit Pzas. Pcs.	Unit Ctn. Pzas. Pcs.	Ship Ctn. Pzas. Pcs.	Std Pkg. Pzas. Pcs.
					Kg	Lb				
	TC-0568	02.03.0568	Tapa cuadrada a prueba de intemperie para 2 contactos duplex. Weatherproof two gang cover for 2 duplex receptacles.	2	24.5	54.0	1	8	32	64
	TC-3252	02.03.3252	Tapa cuadrada a prueba de intemperie para 1 contacto duplex y 1 contacto GFCI. Weatherproof two gang cover for 1 duplex receptacle and 1 GFCI receptacle.	4	24.0	53.0	1	8	32	64
	TC-3253	02.03.3253	Tapa cuadrada a prueba de intemperie para 2 contactos GFCI. Weatherproof two gang cover for 2 GFCI receptacles.	4	23.0	51.0	1	8	32	64

Especificaciones sujetas a cambio sin previo aviso. Specifications are subject to change without notice.

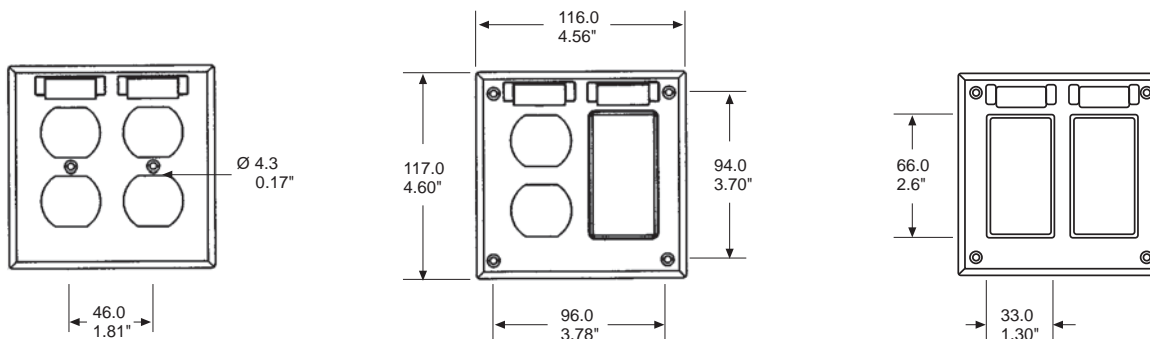

Dimensiones en milímetros y pulgadas. Dimensions in millimeters and inches.

RAWELT, S.A. de C.V.



22 - V - 2009

Cotización/Quotation Plazo de embarque* / Shipment exw* :

Pedido No./Purchase order :

Our ref.:

Fecha/Date: Vendedor/Salesman: No.

Facturar a/Invoice to: RFC.

Ordenado por/Ordered by: Tel. () Fax ()

Dirección/Address:

..... C.P./Zip. Lugar/City/Country:























Consignar a/Ship to:

..... Embarcar: Camión x Cobrar Pagado Paquete

Cond. de Pago/Terms:

Cond. de Venta/Sale conditions: L.P.:

4.2 - SERIE RC. CAJA CUADRADA A PRUEBA DE INTEMPERIE. CON OREJAS DE MONTAJE / WEATHERPROOF TWO GANG BOX. WITH M. LUGS

Figura Figure	Código Code	Medida nominal Hub size		Pqt. Unit. Pzas. Pcs.	Unit. Ctn. Pzas. Pcs.	Ship Ctn. Pzas. Pcs.	Std. Pkg. Pzas. Pcs.	Cantidad Qty.	Figura Figure	Código Code	Medida nominal Hub size		Pqt. Unit. Pzas. Pcs.	Std. Pkg. Pzas. Pcs.	Cantidad Qty.
		mm	inch								mm	inch			
	02.01.0482.M	12.7	1/2	1			24			02.01.0279.M	12.7	1/2	1	24	
	02.01.0483.M	19.0	3/4	1			24			02.01.0280.M	19.0	3/4	1	24	
	02.01.0484.M	12.7	1/2	1			24			02.01.0327.M	12.7	1/2	1	24	
	02.01.0485.M	19.0	3/4	1			24			02.01.0328.M	19.0	3/4	1	24	
	02.01.0502.M	12.7	1/2	1			24			02.01.0406.M	12.7	1/2	1	24	
	02.01.0503.M	19.0	3/4	1			24			02.01.0407.M	19.0	3/4	1	24	
	02.01.0486.M	12.7	1/2	1			24			02.01.0390.M	12.7	1/2	1	24	
	02.01.0487.M	19.0	3/4	1			24			02.01.0391.M	19.0	3/4	1	24	
	02.01.0488.M	12.7	1/2	1			24			02.01.0392.M	12.7	1/2	1	24	
	02.01.0489.M	19.0	3/4	1			24			02.01.0393.M	19.0	3/4	1	24	
	02.01.0492.M	12.7	1/2	1			24			02.01.0396.M	12.7	1/2	1	24	
	02.01.0493.M	19.0	3/4	1			24			02.01.0397.M	19.0	3/4	1	24	
	02.01.0490.M	12.7	1/2	1			24			02.01.0394.M	12.7	1/2	1	24	
	02.01.0491.M	19.0	3/4	1			24			02.01.0395.M	19.0	3/4	1	24	
	02.01.0494.M	12.7	1/2	1			24			02.01.0398.M	12.7	1/2	1	24	
	02.01.0495.M	19.0	3/4	1			24			02.01.0399.M	19.0	3/4	1	24	
	02.01.0498.M	12.7	1/2	1			24			02.01.0402.M	12.7	1/2	1	24	
	02.01.0499.M	19.0	3/4	1			24			02.01.0403.M	19.0	3/4	1	24	
	02.01.0496.M	12.7	1/2	1			24			02.01.0400.M	12.7	1/2	1	24	
	02.01.0497.M	19.0	3/4	1			24			02.01.0401.M	19.0	3/4	1	24	
	02.01.0500.M	12.7	1/2	1			24			02.01.0404.M	12.7	1/2	1	24	
	02.01.0501.M	19.0	3/4	1			24			02.01.0405.M	19.0	3/4	1	24	
	01.04.0371.M	12.7	1/2	25	200	2000									
	01.04.0368.M	19.0	3/4	25	100	1000									

Expediente
 Control
 Embarques
 Almacén
 Producción

- Antes de fincar el pedido en firme, favor de confirmar con fábrica el plazo de embarque definitivo.
- Before place your order, please confirm with RAWELT definitive date of shipment.

Cotización/Quotation Plazo de embarque* / Shipment exw* :

 Pedido No./Purchase order : _____

Our ref.: _____

Fecha/Date: _____ Vendedor/Salesman: _____ No. _____

Facturar a/Invoice to: _____ RFC: _____

Ordenado por/Ordered by: _____ Tel. () _____ Fax () _____

Dirección/Address: _____







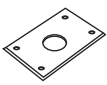
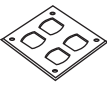

C.P./Zip: _____ Lugar/City/Country: _____

Consignar a/Ship to: _____

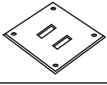
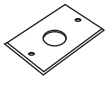
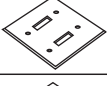
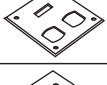
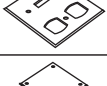
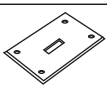
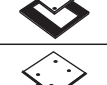
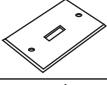
 Embarcar: Camión x Cobrar Pagado Paquete

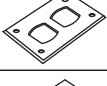
Cond. de Pago/Terms: _____

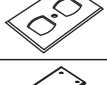
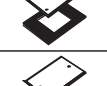
Cond. de Venta/Sale conditions: _____ L.P.: _____

3. - SERIE RR. TAPA Y EMPAQUE / COVER AND GASKET.							4. - SERIE RC. TAPA Y EMPAQUE/COVER AND GASKET.							<input type="checkbox"/> Expediente <input type="checkbox"/> Control <input type="checkbox"/> Embarques <input type="checkbox"/> Almacén <input type="checkbox"/> Producción	
Figura Figure	Código Code	Diametro Ø	Pqt. Unit. Pzas. Pcs.	Unit. Ctn. Pzas. Pcs.	Ship. Ctn. Pzas. Pcs.	Std. Pkg. Pzas. Pcs.	Cantidad Qty.	Figura Figure	Código Code	Pqt. Unit. Pzas. Pcs.	Unit. Ctn. Pzas. Pcs.	Ship. Ctn. Pzas. Pcs.	Std. Pkg. Pzas. Pcs.		Cantidad Qty.
	01.02.0424	Ø 35.23 mm	10	50	200	400			02.02.0417	10	40	160	200		
	01.02.0414	Ø 40.38 mm	10	50	200	400				02.02.0457	10	40	160		200
	01.02.0426	Ø 54.30 mm	10	50	200	400					02.02.0419	10	40		160
	01.02.0425	Ø 35.23 mm	10	50	200	400			02.02.0459		10	40	160	200	
	01.02.0423	Ø 40.38 mm	10	50	200	400				02.02.0510	10	40	160	200	
	01.02.0427	Ø 54.30 mm	10	50	200	400					02.02.0511	10	40	160	
	01.02.0415		10	50	200	400			02.02.1311.G		10	40	120	200	
	01.02.0421		10	50	200	400				02.02.1312.G	10	40	120	200	
	01.02.0385		10	50	200	400				02.04.0430 1/16	10	120	480		
	01.02.0422		10	50	200	400									
	01.02.1309.G		10	40	160	330									
	01.02.1310.G		10	40	160	330									
	01.05.0429 1/16		10	100	700										

- Antes de fincar el pedido en firme, favor de confirmar con fábrica el plazo de embarque definitivo.
- Before place your order, please confirm with RAWELT definitive date of shipment.

Cotización/Quotation Plazo de embarque* / Shipment exw* :

 Pedido No./Purchase order :

Our ref.:

Fecha/Date: Vendedor/Salesman: No.

Facturar a/Invoice to: RFC:

Ordenado por/Ordered by: Tel. () Fax ()

Dirección/Address:





C.P./Zip: Lugar/City/Country:

Consignar a/Ship to:

 Embarcar: Camión x Cobrar Pagado Paquete

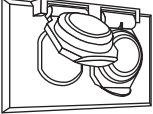
Cond. de Pago/Terms:

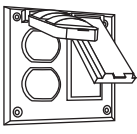
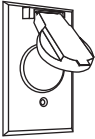
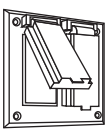
Cond. de Venta/Sale conditions: L.P.:

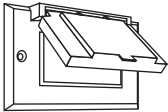
3.- SERIE RR. TAPA A PRUEBA DE INTEMPERIE/WEATHERPROOF COVER.							4.- SERIE RC. TAPA A PRUEBA DE INTEMPERIE/WEATHERPROOF COVER.						
Figura Figure	Código Code	Pqt. Unit. Pzas. Pcs.	Unit. Ctn. Pzas. Pcs.	Ship. Ctn. Pzas. Pcs.	Std. Pkg. Pzas. Pcs.	Cantidad Qty.	Figura Figure	Código Code	Pqt. Unit. Pzas. Pcs.	Unit. Ctn. Pzas. Pcs.	Ship. Ctn. Pzas. Pcs.	Std. Pkg. Pzas. Pcs.	Cantidad Qty.
	01.03.0611	1	12	48	96			02.03.0568	1	8	32	64	
	01.03.0567	1	12	48	96			02.03.3252	1	8	32	64	
	01.03.0563	1	12	48	96			02.03.3253	1	8	32	64	
	01.03.0565	1	12	48	96								
	01.03.3251	1	12	48	96								

 Expediente
 Control
 Embarques
 Almacén
 Producción

- Antes de fincar el pedido en firme, favor de confirmar con fábrica el plazo de embarque definitivo.
- Before place your order, please confirm with RAWELT definitive date of shipment.

**TABLA DE EQUIVALENCIAS.
CROSS REFERENCE GUIDE.**

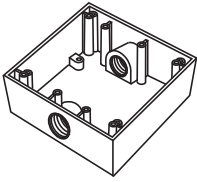
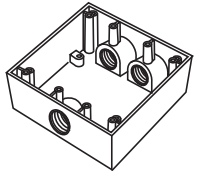
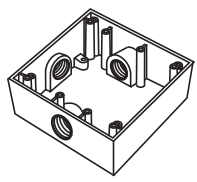
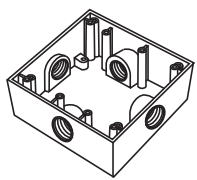
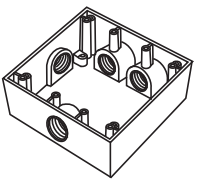
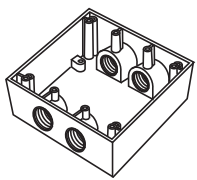
	2 ENTRADAS / 2 HUBS				
	Medida Nominal Size	RAWELT		PERFECT LINE	BWF
		Código Code	Catalogo Catalog	Catalogo Catalog	Catalogo Catalog
	1/2	Sin orejas	02.01.0482	RC-0482	
	3/4	W/out lugs	02.01.0483	RC-0483	
	1/2	Con orejas	02.01.0482.M	RC-0482-M	
3/4	With lugs	02.01.0483.M	RC-0485-M		
	3 ENTRADAS / 3 HUBS				
	Medida Nominal Size	RAWELT		PERFECT LINE	BWF
		Código Code	Catalogo Catalog	Catalogo Catalog	Catalogo Catalog
	1/2	Sin orejas	02.01.0484	RC-0484	
	3/4	W/out lugs	02.01.0485	RC-0485	
	1/2	Con orejas	02.01.0484.M	RC-0484-M	
3/4	With lugs	02.01.0485.M	RC-0485-M		
	3 ENTRADAS / 3 HUBS				
	Medida Nominal Size	RAWELT		PERFECT LINE	BWF
		Código Code	Catalogo Catalog	Catalogo Catalog	Catalogo Catalog
	1/2	Sin orejas	02.01.0502	RC-0502	
	3/4	W/out lugs	02.01.0503	RC-0503	
	1/2	Con orejas	02.01.0502.M	RC-0502-M	
3/4	With lugs	02.01.0503.M	RC-0503-M		
	3 ENTRADAS / 3 HUBS				
	Medida Nominal Size	RAWELT		PERFECT LINE	BWF
		Código Code	Catalogo Catalog	Catalogo Catalog	Catalogo Catalog
	1/2	Sin orejas	02.01.0486	RC-0486	
	3/4	W/out lugs	02.01.0487	RC-0487	
	1/2	Con orejas	02.01.0486.M	RC-0486-M	
3/4	With lugs	02.01.0487.M	RC-0487-M		
	4 ENTRADAS / 4 HUBS				
	Medida Nominal Size	RAWELT		PERFECT LINE	BWF
		Código Code	Catalogo Catalog	Catalogo Catalog	Catalogo Catalog
	1/2	Sin orejas	02.01.0488	RC-0488	
	3/4	W/out lugs	02.01.0489	RC-0489	
	1/2	Con orejas	02.01.0488.M	RC-0488-M	
3/4	With lugs	02.01.0489.M	RC-0489-M		
	4 ENTRADAS / 4 HUBS				
	Medida Nominal Size	RAWELT		PERFECT LINE	BWF
		Código Code	Catalogo Catalog	Catalogo Catalog	Catalogo Catalog
	1/2	Sin orejas	02.01.0492	RC-0492	
	3/4	W/out lugs	02.01.0493	RC-0493	
	1/2	Con orejas	02.01.0492.M	RC-0492-M	
3/4	With lugs	02.01.0493.M	RC-0493-M		

RAWELT, S.A. de C.V.



Una División del Grupo REVUELTA

**TABLA DE EQUIVALENCIAS.
CROSS REFERENCE GUIDE.**

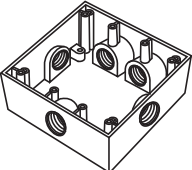
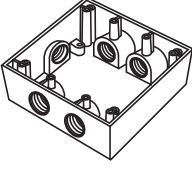
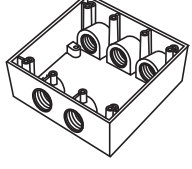
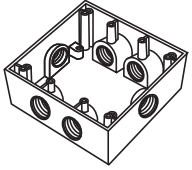
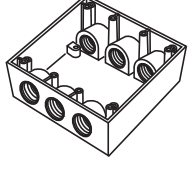
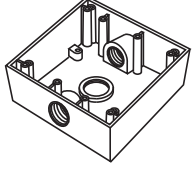
	5 ENTRADAS / 5 HUBS					
	Medida Nominal Size	RAWELT		PERFECT LINE	BWF	
		Código Code	Catalogo Catalog	Catalogo Catalog	Catalogo Catalog	
	1/2	Sin orejas	02.01.0490	RC-0490		
	3/4	W/out lugs	02.01.0491	RC-0491		
1/2	Con orejas	02.01.0490.M	RC-0490-M			
3/4	With lugs	02.01.0491.M	RC-0491-M			
	5 ENTRADAS / 5 HUBS					
	Medida Nominal Size	RAWELT		PERFECT LINE	BWF	
		Código Code	Catalogo Catalog	Catalogo Catalog	Catalogo Catalog	
	1/2	Sin orejas	02.01.0494	RC-0494		
	3/4	W/out lugs	02.01.0495	RC-0495		
1/2	Con orejas	02.01.0494.M	RC-0494-M			
3/4	With lugs	02.01.0495.M	RC-0495-M			
	5 ENTRADAS / 5 HUBS					
	Medida Nominal Size	RAWELT		PERFECT LINE	BWF	
		Código Code	Catalogo Catalog	Catalogo Catalog	Catalogo Catalog	
	1/2	Sin orejas	02.01.0498	RC-0498		
	3/4	W/out lugs	02.01.0499	RC-0499		
1/2	Con orejas	02.01.0498.M	RC-0498-M			
3/4	With lugs	02.01.0499.M	RC-0499-M			
	6 ENTRADAS / 6 HUBS					
	Medida Nominal Size	RAWELT		PERFECT LINE	BWF	
		Código Code	Catalogo Catalog	Catalogo Catalog	Catalogo Catalog	
	1/2	Sin orejas	02.01.0496	RC-0496		
	3/4	W/out lugs	02.01.0497	RC-0497		
1/2	Con orejas	02.01.0496.M	RC-0496-M			
3/4	With lugs	02.01.0497.M	RC-0497-M			
	6 ENTRADAS / 6 HUBS					
	Medida Nominal Size	RAWELT		PERFECT LINE	BWF	
		Código Code	Catalogo Catalog	Catalogo Catalog	Catalogo Catalog	
	1/2	Sin orejas	02.01.0500	RC-0500		
	3/4	W/out lugs	02.01.0501	RC-0501		
1/2	Con orejas	02.01.0500.M	RC-0500-M			
3/4	With lugs	02.01.0501.M	RC-0501-M			
	3 ENTRADAS / 3 HUBS					
	Medida Nominal Size	RAWELT		PERFECT LINE	BWF	
		Código Code	Catalogo Catalog	Catalogo Catalog	Catalogo Catalog	
	1/2	Sin orejas	02.01.0279	RC-0279	LT11	TGB-5
	3/4	W/out lugs	02.01.0280	RC-0280	LT14	TGB-75
1/2	Con orejas	02.01.0279.M	RC-0279-M	LT11-L	TGB-5L	
3/4	With lugs	02.01.0280.M	RC-0280-M	LT14-L	TGB-75L	

RAWELT, S.A. de C.V.

 Una División del Grupo **REVUELTA**

**TABLA DE EQUIVALENCIAS.
CROSS REFERENCE GUIDE.**

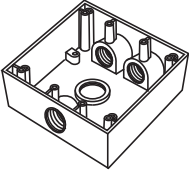
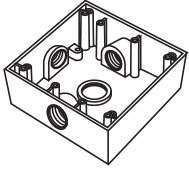
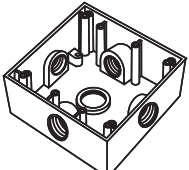
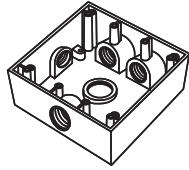
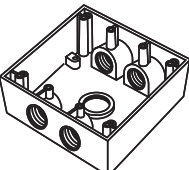
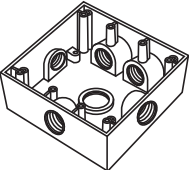
	4 ENTRADAS / 4 HUBS					
	Medida Nominal Size	RAWELT		PERFECT LINE	BWF	
		Código Code	Catalogo Catalog	Catalogo Catalog	Catalogo Catalog	
	1/2	Sin orejas	02.01.0327	RC-0327	LT11-2	TGB-54
	3/4	W/out lugs	02.01.0328	RC-0328	LT14-2	TGB-75-4
	1/2	Con orejas	02.01.0327.M	RC-0327-M	LT11-2L	TGB-5L
3/4	With lugs	02.01.0328.M	RC-0328-M	LT14-2L	TGB-75L	
	4 ENTRADAS / 4 HUBS					
	Medida Nominal Size	RAWELT		PERFECT LINE	BWF	
		Código Code	Catalogo Catalog	Catalogo Catalog	Catalogo Catalog	
	1/2	Sin orejas	02.01.0406	RC-0406		
	3/4	W/out lugs	02.01.0407	RC-0407		
	1/2	Con orejas	02.01.0406.M	RC-0406-M		
3/4	With lugs	02.01.0407.M	RC-0407-M			
	5 ENTRADAS / 5 HUBS					
	Medida Nominal Size	RAWELT		PERFECT LINE	BWF	
		Código Code	Catalogo Catalog	Catalogo Catalog	Catalogo Catalog	
	1/2	Sin orejas	02.01.0390	RC-0390	LTX11-5	TGB-55X
	3/4	W/out lugs	02.01.0391	RC-0391	LTX14-5	TGB-75-5X
	1/2	Con orejas	02.01.0390.M	RC-0390-M	LTX11-5L	TGB-55XL
3/4	With lugs	02.01.0391.M	RC-0391-M	LTX14-5L	TGB-75-5XL	
	5 ENTRADAS / 5 HUBS					
	Medida Nominal Size	RAWELT		PERFECT LINE	BWF	
		Código Code	Catalogo Catalog	Catalogo Catalog	Catalogo Catalog	
	1/2	Sin orejas	02.01.0392	RC-0392		
	3/4	W/out lugs	02.01.0393	RC-0393		
	1/2	Con orejas	02.01.0392.M	RC-0392-M		
3/4	With lugs	02.01.0393.M	RC-0393-M			
	5 ENTRADAS / 5 HUBS					
	Medida Nominal Size	RAWELT		PERFECT LINE	BWF	
		Código Code	Catalogo Catalog	Catalogo Catalog	Catalogo Catalog	
	1/2	Sin orejas	02.01.0396	RC-0396	LT11-3	TGB-55L
	3/4	W/out lugs	02.01.0397	RC-0397	LT14-3	TGB-75-5
	1/2	Con orejas	02.01.0396.M	RC-0396-M	LT11-3L	TGB-55L
3/4	With lugs	02.01.0397.M	RC-0397-M	LT14-3L	TGB-75-5L	
	6 ENTRADAS / 6 HUBS					
	Medida Nominal Size	RAWELT		PERFECT LINE	BWF	
		Código Code	Catalogo Catalog	Catalogo Catalog	Catalogo Catalog	
	1/2	Sin orejas	02.01.0394	RC-0394	LTX11-6	
	3/4	W/out lugs	02.01.0395	RC-0395	LTX14-6	
	1/2	Con orejas	02.01.0394.M	RC-0394-M	LTX11-6L	TGB-56XL
3/4	With lugs	02.01.0395.M	RC-0395-M	LTX14-6L	TGB-75-6XL	

RAWELT, S.A. de C.V.

 **RAWELT**® INYECTADOS

Una División del Grupo  **REVUELTA**

**TABLA DE EQUIVALENCIAS.
CROSS REFERENCE GUIDE.**

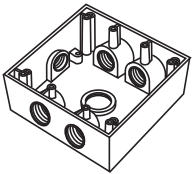
	6 ENTRADAS / 6 HUBS				
	Medida Nominal Size	RAWELT		PERFECT LINE	BWF
		Código Code	Catalogo Catalog	Catalogo Catalog	Catalogo Catalog
1/2	Sin orejas	02.01.0398	RC-0398		
3/4	W/out lugs	02.01.0399	RC-0399		
1/2	Con orejas	02.01.0398.M	RC-0398-M		
3/4	With lugs	02.01.0399.M	RC-0399-M		

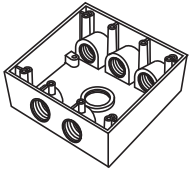
	6 ENTRADAS / 6 HUBS				
	Medida Nominal Size	RAWELT		PERFECT LINE	BWF
		Código Code	Catalogo Catalog	Catalogo Catalog	Catalogo Catalog
1/2	Sin orejas	02.01.0402	RC-0402		
3/4	W/out lugs	02.01.0403	RC-0403		
1/2	Con orejas	02.01.0402.M	RC-0402-M		
3/4	With lugs	02.01.0403.M	RC-0403-M		

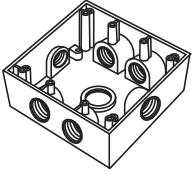
	7 ENTRADAS / 7 HUBS				
	Medida Nominal Size	RAWELT		PERFECT LINE	BWF
		Código Code	Catalogo Catalog	Catalogo Catalog	Catalogo Catalog
1/2	Sin orejas	02.01.0400	RC-0400	LTX11-7	
3/4	W/out lugs	02.01.0401	RC-0401	LTX14-7	
1/2	Con orejas	02.01.0400.M	RC-0400-M	LTX11-7L	
3/4	With lugs	02.01.0401.M	RC-0401-M	LTX14-7L	

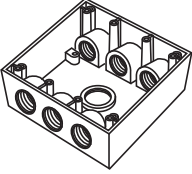
	7 ENTRADAS / 7 HUBS				
	Medida Nominal Size	RAWELT		PERFECT LINE	BWF
		Código Code	Catalogo Catalog	Catalogo Catalog	Catalogo Catalog
1/2	Sin orejas	02.01.0404	RC-0404	LT11-33	TGB-57
3/4	W/out lugs	02.01.0405	RC-0405	LT14-33	TGB-77
1/2	Con orejas	02.01.0404.M	RC-0404-M	LT11-33L	TGB-57L
3/4	With lugs	02.01.0405.M	RC-0405-M	LT14-33L	TGB-77L

Rawelt, S.A. de C.V. no asume ninguna responsabilidad por omisiones, errores, diferencias, en el diseño o función entre los productos arriba mencionados.

Rawelt, S.A. de C.V. assumes no liability for omission, errors, differences between bodies above mentioned or change in design or function.

RAWELT, S.A. de C.V.

 Una División del Grupo **REVUELTA**

2 - I - 2001