

PRODUCTOS PARA INSTALACIONES ELECTRICAS

Products for electrical installations

INYECTADOS



RAWELT[®]

DIECAST



Cajas para áreas peligrosas libres de cobre



Cajas Ovais

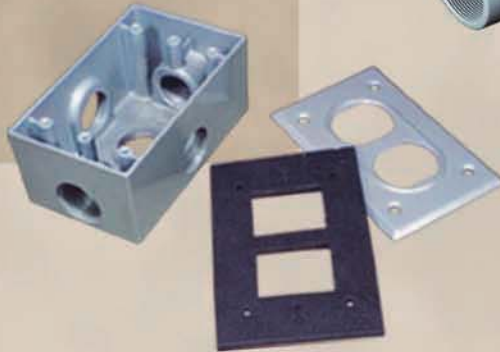

Cajas Rectangulares y Cuadradas

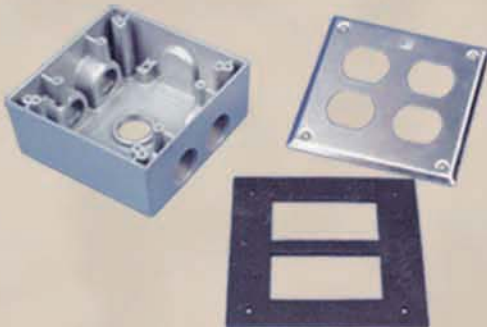

Cajas Unión



Luminarias a prueba de intemperie



Tuercas Unión para áreas peligrosas



Sellos para áreas peligrosas



Luminaria Industrial HID para áreas peligrosas



Lámparas Luz de Obstrucción



Vaso de Cristal

Lámparas a prueba de vapor



Vaso de Policarbonato

Folleto RW 20

3.1 - CAJA RECTANGULAR. A PRUEBA DE INTEMPERIE. SERIE RR.

3.1 - WEATHERPROOF SINGLE GANG BOX. RR SERIES.

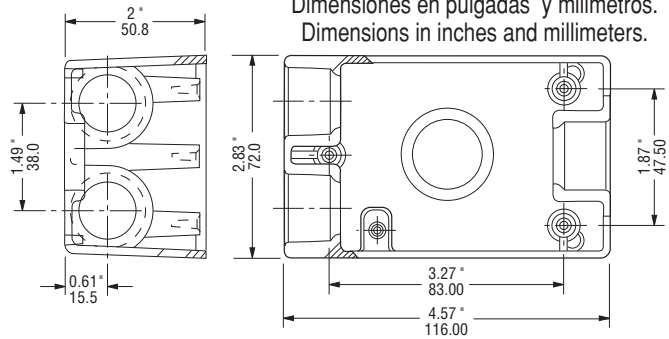

- Material: Aluminio inyectado a presión (diecast).
- Acabados: Pintura electrostática epoxica/poliéster polimerizada.
- Tornillo de tierra pasivado incluido.
- A prueba de intemperie cuando se usa tapa con empaque.
- Rosca NPT para usarse con tubo conduit RIGIDO e IMC.

APLICACIONES:

- Pueden ser instaladas para recibir accesorios como: Interruptores, contactos, estaciones de botones, luces piloto.
- Sirven para hacer empalmes y conexiones en el cableado. Permite fácil acceso para mantenimiento.
- Fabricación en base a: UL 514 A, UL 514 B
CAN/CSA-C22.2 No. 18-92

- Material: Diecast aluminum
- Finish: Electrostatic powder epoxy/poliéster coating.
- Green ground screw included.
- For wet location when gasketed cover are used.
- NPT threaded for use with RIGID and IMC conduit.

APPLICATIONS:

- They can be installed to accommodate accessories such as switches, receptacles.
- Provide openings for making splice and taps. Allow access for maintenance.
- Manufactured in compliance with: UL 514 A, UL 514 B
CAN/CSA-C22.2 No. 18-92

USAR No. DE CODIGO PARA HACER PEDIDOS / TO ORDER USE CODE NUMBER

Figura Figure	Bocas Hubs	Catalogo Catalog	Codigo Code	Medida nominal Hub size		Volumen Volume		Peso x 100 pzas. Weight x 100 pcs.		Pqt. Unit.	Unit. Ctn.	Ship. Ctn.	Std. Pkg.
				mm	inch	cm ³	cu. in	kg	Lb				
	Arriba/Top	1	RR-0505	01.01.0505	12.7	1/2"	308.3	18.8	22.0	48.5			40
			RR-0506	01.01.0506	19.0	3/4"	308.3	18.8	19.5	42.9			40
			RR-2631	01.01.2631	25.4	1"	246.0	15.0	27.0	58.3			40
	Arriba/Top Abajo/Bottom	1 1	RR-0470	01.01.0470	12.7	1/2"	300.1	18.3	24.0	52.9			40
			RR-0471	01.01.0471	19.0	3/4"	295.2	18.0	22.0	48.5			40
			RR-2742	01.01.2742	25.4	1"	246.0	15.0	27.0	58.3			40
	Arriba/Top Abajo/Bottom	1 2	RR-0472	01.01.0472	12.7	1/2"	275.5	16.8	29.5	65.0			40
			RR-0473	01.01.0473	19.0	3/4"	275.5	16.8	26.5	58.4			40
	Arriba/Top Abajo/Bottom Izquierda/Left	1 1 1	RR-0480	01.01.0480	12.7	1/2"	275.5	16.8	30.0	66.1			40
			RR-0481	01.01.0481	19.0	3/4"	275.5	16.8	27.5	60.6			40
			RR-2743	01.01.2743	25.4	1"	234.5	14.3	28.5	62.7			40
	Arriba/Top Abajo/Bottom Izquierda/Left Derecha/Right	1 1 1 1	RR-0474	01.01.0474	12.7	1/2"	275.5	16.8	32.5	71.6			40
			RR-0475	01.01.0475	19.0	3/4"	275.5	16.8	26.5	58.4			40
			RR-2744	01.01.2744	25.4	1"	234.5	14.3	28.5	62.7			40

Especificaciones sujetas a cambio sin previo aviso. Specifications are subject to change without notice..

RAWELT, S.A. de C.V.



3.1 - CAJA RECTANGULAR. A PRUEBA DE INTEMPERIE. SERIE RR.

Hoja: 2 / 5
Page:

3.1 - WEATHERPROOF SINGLE GANG BOX. RR SERIES.

FICHA TECNICA / TECHNICAL DATA

007 - RW - 154

USAR No. DE CODIGO PARA HACER PEDIDOS / TO ORDER USE CODE NUMBER

Figura Figure	Bocas Hubs	Catalogo Catalog	Codigo Code	Medida nominal Hub size		Volumen Volume		Peso x 100 pzas. Weight x 100 pcs.		Pqt. Unit. Pzas. Pcs.	Unit. Ctn. Pzas. Pcs.	Ship. Ctn. Pzas. Pcs.	Std. Pkg. Pzas. Pcs.
				mm	cu. in	cm ³	cu. in	kg	Lb				
	Arriba/Top 22	RR-0476	01.01.0476	12.7	1/2	267.3	16.3	30.5	67.2				40
	Abajo/Bottom	RR-0477	01.01.0477	19.0	3/4	267.3	16.3	26.0	57.3				40
	Arriba/Top 1	RR-0478	01.01.0478	12.7	1/2	267.3	16.3	32.0	70.5				40
	Abajo/Bottom 1												
	Izquierda/Left 2	RR-0479	01.01.0479	19.0	3/4	267.3	16.3	28.5	62.8				40
	Derecha/Right 1												
	Arriba/Top 1	RR-0507	01.01.0507	12.7	1/2	308.3	18.8	21.0	46.2				40
	Detrás/Back 1	RR-0508	01.01.0508	19.0	3/4	303.4	18.5	18.5	40.7				40
		RR-2745	01.01.2745	25.4	1	246.0	15.0	27.0	58.3				40
	Arriba/Top 1	RR-0281	01.01.0281	12.7	1/2	300.1	18.3	24.5	54				40
	Abajo/Bottom 1	RR-0282	01.01.0282	19.0	3/4	295.2	18.0	31.0	68.3				40
	Detrás/Back 1	RR-2746	01.01.2746	25.4	1	246.0	15.0	27.0	58.3				40
	Arriba/Top 1	RR-0283	01.01.0283	12.7	1/2	275.5	16.8	29.0	63.9				40
	Abajo/Bottom 2												
	Detrás/Back 1	RR-0284	01.01.0284	19.0	3/4	275.5	16.8	26.0	57.3				40
	Arriba/Top 1	RR-0454	01.01.0454	12.7	1/2	275.5	16.8	29.5	65.0				40
	Abajo/Bottom 1												
	Izquierda/Left 1	RR-0455	01.01.0455	19.0	3/4	275.5	16.8	27.0	59.5				40
	Detrás/Back 1	RR-2747	01.01.2747	25.4	1	234.5	14.3	28.5	62.7				40
	Arriba/Top 1	RR-0285	01.01.0285	12.7	1/2	275.5	16.8	32.0	70.5				40
	Abajo/Bottom 1												
	Izquierda/Left 1	RR-0286	01.01.0286	19.0	3/4	275.5	16.8	26.0	57.3				40
	Derecha/Right 1												
	Detrás/Back 1	RR-2748	01.01.2748	25.4	1	234.5	14.3	28.5	62.7				40
	Arriba/Top 2	RR-0287	01.01.0287	12.7	1/2	267.3	16.3	29.5	65.0				40
	Abajo/Bottom 2												
	Detrás/Back 1	RR-0288	01.01.0288	19.0	3/4	267.3	16.3	25.5	56.2				40
	Arriba/Top 1												
	Abajo/Bottom 1												
	Izquierda/Left 2	RR-0289	01.01.0289	12.7	1/2	267.3	16.3	31.5	69.4				40
	Derecha/Right 1												
Detrás/Back 1	RR-0290	01.01.0290	19.0	3/4	267.3	16.3	28.0	61.7				40	

Certificaciones / Compliances: Expediente/File No. LR 105795-1

Expediente/File No. E135600

Cajas 25.4 1"
 Boxes 25.4 1"

Especificaciones sujetas a cambio sin previo aviso. Specifications are subject to change without notice..

RAWELT, S.A. de C.V.

RAWELT INYECTADOS

Una División del Grupo **REBUelta**

22 - V - 2009

3.1 - CAJA RECTANGULAR. A PRUEBA DE INTEMPERIE. SERIE RR.

3.1 - WEATHERPROOF SINGLE GANG BOX. RR SERIES.

FICHA TECNICA / TECHNICAL DATA

007-RW-154

TAPA

- Lámina de aluminio troquelada.
- Uso en interiores.
- Tornillos galvanizados incluidos.

EMPAQUE

- Neopreno

TAPON

- Aluminio inyectado a presión (diecast).

COVER

- Sheet aluminum.
- For use indoors.
- Galvanized mounting screws included.

GASKET

- Neoprene.

CLOSE UP PLUG

- Die cast aluminum.

Dimensiones en milímetros y pulgadas.
Dimensions in inches and millimeters.

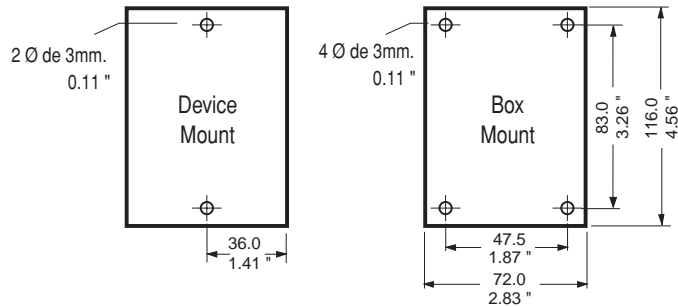

LISTED
1M70



USAR No. DE CODIGO PARA HACER PEDIDOS / TO ORDER USE CODE NUMBER

Figura Figure	Catalogo Catalog	Codigo Code	Descripción Description	Cant. Diam. Qty.	Espesor Thickness		Peso x 100 pzas. Weight x 100 pcs.		Pqt. Unit Pzas. Pcs.	Unit Ctn. Pzas. Pcs.	Ship Ctn. Pzas. Pcs.	Std. Pkg. Pzas. Pcs.
					mm	inch	kg	Lb				
	TR-0424	01.02.0424	Tapa rectangular para contacto de 35.23 mm Ø 1 3/8". Single gang round receptacle cover 1 3/8" diameter hole. Box mount.	4	1.02	.040	2.1	4.6	10	50	200	400
	TR-0414	01.02.0414	Tapa rectangular para contacto de 40.38 mm Ø 1 9/16". Single gang round receptacle cover 1 9/16" diameter hole. Box mount.	4	1.02	.040	2.0	4.4	10	50	200	400
	TR-0426	01.02.0426	Tapa rectangular para contacto de 54.30 mm Ø 2 1/8". Single gang round receptacle cover 2 1/8" diameter hole. Box mount.	4	1.02	.040	1.7	3.7	10	50	200	400
	TR-0425	01.02.0425	Tapa rectangular para contacto de 35.23 mm Ø 1 3/8". Single gang round receptacle cover 1 3/8" diameter hole. Device mount.	2	1.02	.040	2.1	4.6	10	50	200	400
	TR-0423	01.02.0423	Tapa rectangular para contacto de 40.38 mm Ø 1 9/16". Single gang round receptacle cover 1 9/16" diameter hole. Device mount.	2	1.02	.040	2.0	4.4	10	50	200	400
	TR-0427	01.02.0427	Tapa rectangular para contacto de 54.30 mm Ø 2 1/8". Single gang round receptacle cover 2 1/8" diameter hole. Device mount.	2	1.02	.040	1.8	4.0	10	50	200	400
	TR-0415	01.02.0415	Tapa rectangular para interruptor Single gang toggle switch cover. Box mount.	4	1.02	.040	2.3	5.1	10	50	200	400
	TR-0421	01.02.0421	Tapa rectangular para interruptor Single gang toggle switch cover. Device mount.	2	1.02	.040	2.3	5.1	10	50	200	400

Especificaciones sujetas a cambio sin previo aviso. Specifications are subject to change without notice..

RAWELT, S.A. de C.V.



Una División del Grupo REVUELTA

22 - V - 2009

3.1 - CAJA RECTANGULAR. A PRUEBA DE INTEMPERIE. SERIE RR.

Hoja: 4 / 5
Page:

3.1 - WEATHERPROOF SINGLE GANG BOX. RR SERIES.

FICHA TECNICA / TECHNICAL DATA

007-RW-154

USAR No. DE CODIGO PARA HACER PEDIDOS / TO ORDER USE CODE NUMBER

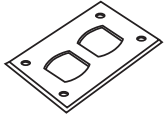
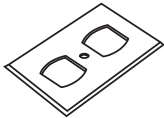
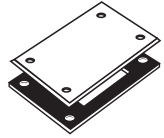
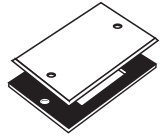
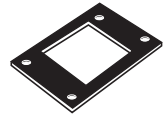
Figura Figure	Catalogo Catalog	Codigo Code	Descripción Description	Cant. Diam. Qty.	Espesor Thickness		Peso x 100 pzas. Weight x 100 pcs.		Pqt. Unit Pzas. Pcs.	Unit Ctn. Pzas. Pcs.	Ship Ctn. Pzas. Pcs.	Std. Pkg. Pzas. Pcs.
					mm	inch	kg	Lb				
	TR-0385	01.02.0385	Tapa rectangular para contacto duplex. Single gang duplex receptacle cover. Box mount.	4	1.02	.040	2.0	4.4	10	50	200	400
	TR-0422	01.02.0422	Tapa rectangular para contacto duplex. Single gang duplex receptacle cover. Device mount.	1	1.02	.040	1.9	4.2	10	50	200	400
	TR-0416 ERN-0429	01.02.1309.G	Tapa rectangular ciega con empaque. Weatherproof single gang blank cover. Box mount with gasket.	4	1.02	.040	2.4	5.3	10	40	160	330
	TR-0420 ERN-0429	01.02.1310.G	Tapa rectangular ciega con empaque. Weatherproof single gang blank cover. Device mount with gasket.	2	1.02	.040	2.4	5.3	10	40	160	330
	ERN-0429	01.05.0429	Empaque de Neopreno tipo rectangular. Neoprene gasket.	4	1.6	1/16	1.0	2.2	10	100	700	

TAPONES / PLUGS

USAR No. DE CODIGO PARA HACER PEDIDOS / TO ORDER USE CODE NUMBER

Figura Figure	Catalogo Catalog	Codigo Code	Descripción Description	Medida nominal Hub size		Peso x 100 pzas. Weight x 100 pcs.		Pqt. Unit Pzas. Pcs.	Unit Ctn. Pzas. Pcs.	Ship Ctn. Pzas. Pcs.	Std. Pkg. Pzas. Pcs.
				mm	inch	kg	Lb				
	TA-0371	01.04.0371	Tapón roscado. Close-up plug.	12.7	1/2	1.0	2.2	25	200	2000	
	TA-0368	01.04.0368		19.0	3/4	1.3	2.9	25	100	1000	
	TA-2632	01.04.2632		25.4	1	1.7	3.7	25	100	1000	

Certificaciones / Compliances:  Expediente/File No. LR 105795-1

 Expediente/File No. E135600

 Tapones
Closure plugs

Especificaciones sujetas a cambio sin previo aviso. Specifications are subject to change without notice.

RAWELT, S.A. de C.V.

 **RAWELT** INYECTADOS
Una División del Grupo **REVUELTA**

22 - V - 2009

3.1 - CAJA RECTANGULAR. A PRUEBA DE INTEMPERIE. SERIE RR.

3.1 - WEATHERPROOF SINGLE GANG BOX. RR SERIES.



TAPA

- Material: Aluminio inyectado a presión (diecast).
- Acabados: Pintura electrostática epoxica/poliéster polimerizada.
- Para uso en interiores y exteriores.
- Provee protección contra la intemperie cuando el receptáculo no está en uso.
- Empaque y tornillos galvanizados incluidos.
- Contratapa con mecanismo de auto-cierre.

COVER

- Diecast aluminum.
- Finish: Electrostatic powder epoxy/poliéster coating.
- For use indoors and outdoors.
- Provides weatherproof protection when the receptacle is not in use.
- Gasket and galvanized mounting screws included.
- Self-closing cover.

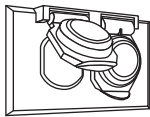
USAR No. DE CODIGO PARA HACER PEDIDOS / TO ORDER USE CODE NUMBER

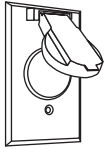
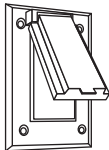
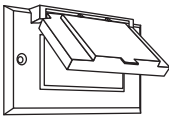
Figura Figure	Catalogo Catalog	Codigo Code	Descripción Description	Cant. Diam. Qty.	Peso x 100 pzas. Weight x 100 pcs.		Pqt. Unit Pzas. Pcs.	Unit Ctn. Pzas. Pcs.	Ship Ctn. Pzas. Pcs.	Std Pkg. Pzas. Pcs.
					kg	Lb				
	TR-0611	01.03.0611	Tapa rectangular a prueba de intemperie para contacto duplex horizontal. Weatherproof single gang horizontal cover for duplex receptacles.	1	16.0	35.0	1	12	48	96
	TR-0567	01.03.0567	Tapa rectangular a prueba de intemperie para contacto duplex vertical. Weatherproof single gang vertical cover for duplex receptacles.	1	13.0	29.0	1	12	48	96
	TR-0563	01.03.0563	Tapa rectangular a prueba de intemperie para contacto de 37.5 mm (1.47"). Weatherproof single gang round receptacle cover with 1.47" diameter hole.	2	13.0	29.0	1	12	48	96
	TR-0565	01.03.0565	Tapa rectangular a prueba de intemperie para contacto GFCI vertical. Weatherproof single gang vertical cover for GFCI receptacles.	4	14.0	31.0	1	12	48	96
	TR-3251	01.03.3251	Tapa rectangular a prueba de intemperie para contacto GFCI horizontal. Weatherproof single gang horizontal cover for GFCI receptacles.	2	15.5	34.0	1	12	48	96

Especificaciones sujetas a cambio sin previo aviso. Specifications are subject to change without notice.

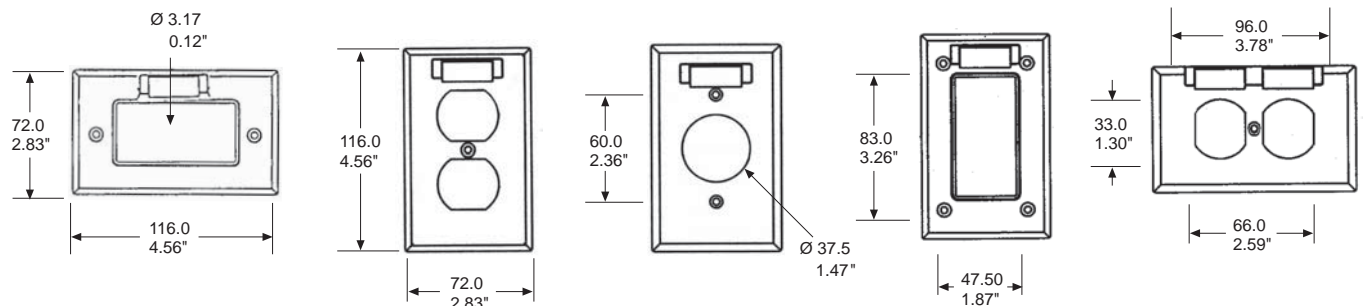

Dimensiones en milímetros y pulgadas. Dimensions in millimeters and inches.

RAWELT, S.A. de C.V.



03 - IX - 2007

Cotización/Quotation Plazo de embarque* / Shipment exw* :

 Pedido No./Purchase order :

Our ref.:

Fecha/Date: Vendedor/Salesman: No.

Facturar a/Invoice to: RFC.

Ordenado por/Ordered by: Tel. () Fax ()

Dirección/Address:















C.P./Zip: Lugar/City/Country:

Consignar a/Ship to:

 Embarcar: Camión x Cobrar Pagado Paquete

Cond. de Pago/Terms:

Cond. de Venta/Sale conditions: L.P.:

3.1 - SERIE RR. CAJA RECTANGULAR A PRUEBA DE INTEMPERIE / WEATHERPROOF SINGLE GANG BOX.														
Figura Figure	Código Code	Medida nominal Hub size		Pgt. Unit. Pzas. Pcs.	Unit. Ctn. Pzas. Pcs.	Ship. Ctn. Pzas. Pcs.	Std. Pkg. Pzas. Pcs.	Cantidad Qty.	Figura Figure	Código Code	Medida nominal Hub size		Std. Pkg. Pzas. Pcs.	Cantidad Qty.
		mm	inch								mm	inch		
	01.01.0505	12.7	1/2				40		01.01.0507	12.7	1/2	40		
	01.01.0506	19.0	3/4				40		01.01.0508	19.0	3/4	40		
	01.01.2631	25.4	1				40		01.01.2745	25.4	1	40		
	01.01.0470	12.7	1/2				40		01.01.0281	12.7	1/2	40		
	01.01.0471	19.0	3/4				40		01.01.0282	19.0	3/4	40		
	01.01.2742	25.4	1				40		01.01.2746	25.4	1	40		
	01.01.0472	12.7	1/2				40		01.01.0283	12.7	1/2	40		
	01.01.0473	19.0	3/4				40		01.01.0284	19.0	3/4	40		
	01.01.0480	12.7	1/2				40		01.01.0454	12.7	1/2	40		
	01.01.0481	19.0	3/4				40		01.01.0455	19.0	3/4	40		
	01.01.2743	25.4	1				40		01.01.2747	25.4	1	40		
	01.01.0474	12.7	1/2				40		01.01.0285	12.7	1/2	40		
	01.01.0475	19.0	3/4				40		01.01.0286	19.0	3/4	40		
	01.01.2744	25.4	1				40		01.01.2748	25.4	1	40		
	01.01.0476	12.7	1/2				40		01.01.0287	12.7	1/2	40		
	01.01.0477	19.0	3/4				40		01.01.0288	19.0	3/4	40		
	01.01.0478	12.7	1/2				40		01.01.0289	12.7	1/2	40		
	01.01.0479	19.0	3/4				40		01.01.0290	19.0	3/4	40		
	01.04.0371	12.7	1/2	25	200	2000								
	01.04.0368	19.0	3/4	25	100	1000								
	01.04.2632	25.4	1	25	100	1000								

 Expediente
 Control
 Embarques
 Almacén
 Producción

- Antes de fincar el pedido en firme, favor de confirmar con fábrica el plazo de embarque definitivo.
- Before place your order, please confirm with RAWELT definitive date of shipment.

Cotización/Quotation Plazo de embarque* / Shipment exw* :

 Pedido No./Purchase order : _____

Our ref.: _____

Fecha/Date: _____ Vendedor/Salesman: _____ No. _____

Facturar a/Invoice to: _____ RFC: _____

Ordenado por/Ordered by: _____ Tel. () _____ Fax () _____

Dirección/Address: _____







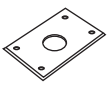
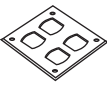

C.P./Zip: _____ Lugar/City/Country: _____

Consignar a/Ship to: _____

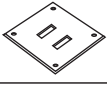
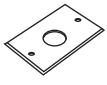
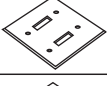
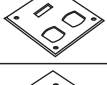
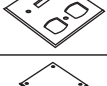
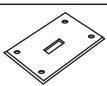
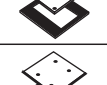
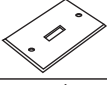
 Embarcar: Camión x Cobrar Pagado Paquete

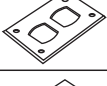
Cond. de Pago/Terms: _____

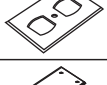
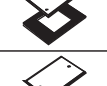
Cond. de Venta/Sale conditions: _____ L.P.: _____

3. - SERIE RR. TAPA Y EMPAQUE / COVER AND GASKET.							4. - SERIE RC. TAPA Y EMPAQUE/COVER AND GASKET.							<input type="checkbox"/> Expediente <input type="checkbox"/> Control <input type="checkbox"/> Embarques <input type="checkbox"/> Almacén <input type="checkbox"/> Producción	
Figura Figure	Código Code	Diametro Ø	Pqt. Unit. Pzas. Pcs.	Unit. Ctn. Pzas. Pcs.	Ship. Ctn. Pzas. Pcs.	Std. Pkg. Pzas. Pcs.	Cantidad Qty.	Figura Figure	Código Code	Pqt. Unit. Pzas. Pcs.	Unit. Ctn. Pzas. Pcs.	Ship. Ctn. Pzas. Pcs.	Std. Pkg. Pzas. Pcs.		Cantidad Qty.
	01.02.0424	Ø 35.23 mm	10	50	200	400			02.02.0417	10	40	160	200		
	01.02.0414	Ø 40.38 mm	10	50	200	400				02.02.0457	10	40	160		200
	01.02.0426	Ø 54.30 mm	10	50	200	400					02.02.0419	10	40		160
	01.02.0425	Ø 35.23 mm	10	50	200	400			02.02.0459		10	40	160	200	
	01.02.0423	Ø 40.38 mm	10	50	200	400				02.02.0510	10	40	160	200	
	01.02.0427	Ø 54.30 mm	10	50	200	400					02.02.0511	10	40	160	
	01.02.0415		10	50	200	400			02.02.1311.G		10	40	120	200	
	01.02.0421		10	50	200	400				02.02.1312.G	10	40	120	200	
	01.02.0385		10	50	200	400				02.04.0430 1/16	10	120	480		
	01.02.0422		10	50	200	400									
	01.02.1309.G		10	40	160	330									
	01.02.1310.G		10	40	160	330									
	01.05.0429 1/16		10	100	700										

- Antes de fincar el pedido en firme, favor de confirmar con fábrica el plazo de embarque definitivo.
- Before place your order, please confirm with RAWELT definitive date of shipment.

Cotización/Quotation Plazo de embarque* / Shipment exw* :

 Pedido No./Purchase order :

Our ref.:

Fecha/Date: Vendedor/Salesman: No.

Facturar a/Invoice to: RFC:

Ordenado por/Ordered by: Tel. () Fax ()

Dirección/Address:



C.P./Zip: Lugar/City/Country:

Consignar a/Ship to:

 Embarcar: Camión x Cobrar Pagado Paquete

Cond. de Pago/Terms:

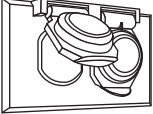
Cond. de Venta/Sale conditions: L.P.:

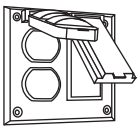
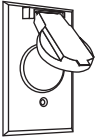
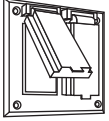
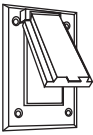
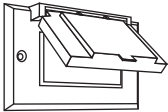
3.- SERIE RR. TAPA A PRUEBA DE INTEMPERIE/WEATHERPROOF COVER.							4.- SERIE RC. TAPA A PRUEBA DE INTEMPERIE/WEATHERPROOF COVER.						
Figura Figure	Código Code	Pqt. Unit. Pzas. Pcs.	Unit. Ctn. Pzas. Pcs.	Ship. Ctn. Pzas. Pcs.	Std. Pkg. Pzas. Pcs.	Cantidad Qty.	Figura Figure	Código Code	Pqt. Unit. Pzas. Pcs.	Unit. Ctn. Pzas. Pcs.	Ship. Ctn. Pzas. Pcs.	Std. Pkg. Pzas. Pcs.	Cantidad Qty.
	01.03.0611	1	12	48	96			02.03.0568	1	8	32	64	
	01.03.0567	1	12	48	96			02.03.3252	1	8	32	64	
	01.03.0563	1	12	48	96			02.03.3253	1	8	32	64	
	01.03.0565	1	12	48	96								
	01.03.3251	1	12	48	96								

 Expediente
 Control
 Embarques
 Almacén
 Producción

- Antes de fincar el pedido en firme, favor de confirmar con fábrica el plazo de embarque definitivo.
- Before place your order, please confirm with RAWELT definitive date of shipment.

**TABLA DE EQUIVALENCIAS.
CROSS REFERENCE GUIDE.**

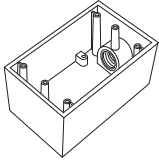
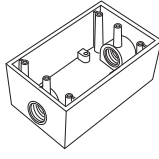
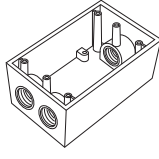
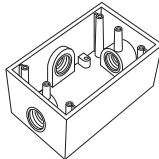
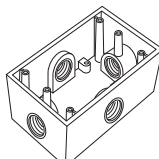
		1 ENTRADA / 1 HUB					
	Medida Nominal Size	RAWELT		CROUSE-HINDS		PERFECT LINE	BWF
		Código Code	Catalogo Catalog	Catalogo Catalog	Catalogo Catalog	Catalogo Catalog	Catalogo Catalog
	1/2	Sin orejas	01.01.0505	RR-0505	Sin orejas	FS1	
	3/4	W/out lugs	01.01.0506	RR-0506	W/out lugs	FS2	
	1		01.01.2631	RR-2631		FS3	
	1/2	Con orejas	01.01.0505.M	RR-0505-M			
	3/4	With lugs	01.01.0506.M	RR-0506-M			
	1		01.01.2631.M	RR-2631-M			
		2 ENTRADAS / 2 HUBS					
	Medida Nominal Size	RAWELT		CROUSE-HINDS		PERFECT LINE	BWF
		Código Code	Catalogo Catalog	Catalogo Catalog	Catalogo Catalog	Catalogo Catalog	Catalogo Catalog
	1/2	Sin orejas	01.01.0470	RR-0470	Sin orejas	FSC1	
	3/4	W/out lugs	01.01.0471	RR-0471	W/out lugs	FSC2	
	1		01.01.2742	RR-2742		FSC3	
	1/2	Con orejas	01.01.0470.M	RR-0470-M			
	3/4	With lugs	01.01.0471.M	RR-0471-M			
	1		01.01.2742.M	RR-2742-M			
		3 ENTRADAS / 3 HUBS					
	Medida Nominal Size	RAWELT		CROUSE-HINDS		PERFECT LINE	BWF
		Código Code	Catalogo Catalog	Catalogo Catalog	Catalogo Catalog	Catalogo Catalog	Catalogo Catalog
	1/2	Sin orejas	01.01.0472	RR-0472	Sin orejas	FSCC1	
	3/4	W/out lugs	01.01.0473	RR-0473	W/out lugs	FSCC2	
	1/2	Con orejas	01.01.0472.M	RR-0472-M			
	3/4	With lugs	01.01.0473.M	RR-0473-M			
		3 ENTRADAS / 3 HUBS					
	Medida Nominal Size	RAWELT		CROUSE-HINDS		PERFECT LINE	BWF
		Código Code	Catalogo Catalog	Catalogo Catalog	Catalogo Catalog	Catalogo Catalog	Catalogo Catalog
	1/2	Sin orejas	01.01.0480	RR-0480	Sin orejas	FSCT1	
	3/4	W/out lugs	01.01.0481	RR-0481	W/out lugs	FSCT2	
	1		01.01.2743	RR-2743		FSCT3	
	1/2	Con orejas	01.01.0480.M	RR-0480-M			
	3/4	With lugs	01.01.0481.M	RR-0481-M			
	1		01.01.2743.M	RR-2743-M			
		4 ENTRADAS / 4 HUBS					
	Medida Nominal Size	RAWELT		CROUSE-HINDS		PERFECT LINE	BWF
		Código Code	Catalogo Catalog	Catalogo Catalog	Catalogo Catalog	Catalogo Catalog	Catalogo Catalog
	1/2	Sin orejas	01.01.0474	RR-0474	Sin orejas	FSX1	
	3/4	W/out lugs	01.01.0475	RR-0475	W/out lugs	FSX2	
	1		01.01.2744	RR-2744		FSX3	
	1/2	Con orejas	01.01.0474.M	RR-0474-M			
	3/4	With lugs	01.01.0475.M	RR-0475-M			
	1		01.01.2744.M	RR-2744-M			

RAWELT, S.A. de C.V.

 **RAWELT**® INYECTADOS
Una División del Grupo  **REVUELTA**

2 - I - 2001

3.1, 3.2 - CAJA RECTANGULAR. A PRUEBA DE INTEMPERIE. SERIE RR.

Hoja: 2 / 3
Page:

FICHA TECNICA / TECHNICAL DATA

3.1, 3.2 - WEATHERPROOF SINGLE GANG BOX. RR SERIES.

007-RW-259

**TABLA DE EQUIVALENCIAS.
CROSS REFERENCE GUIDE.**

4 ENTRADAS / 4 HUBS						
Medida Nominal Size	RAWELT			CROUSE-HINDS	PERFECT LINE	BWF
	Código Code	Catalogo Catalog	Catalogo Catalog	Catalogo Catalog	Catalogo Catalog	Catalogo Catalog
1/2	Sin orejas	01.01.0476	RR-0476	Sin orejas	FSCD1	
3/4	W/out lugs	01.01.0477	RR-0477	W/out lugs	FSCD2	
1/2	Con orejas	01.01.0476.M	RR-0476-M			
3/4	With lugs	01.01.0477.M	RR-0477-M			

5 ENTRADAS / 5 HUBS						
Medida Nominal Size	RAWELT			CROUSE-HINDS	PERFECT LINE	BWF
	Código Code	Catalogo Catalog	Catalogo Catalog	Catalogo Catalog	Catalogo Catalog	Catalogo Catalog
1/2	Sin orejas	01.01.0478	RR-0478			
3/4	W/out lugs	01.01.0479	RR-0479			
1/2	Con orejas	01.01.0478.M	RR-0478-M			
3/4	With lugs	01.01.0479.M	RR-0479-M			

2 ENTRADAS / 2 HUBS						
Medida Nominal Size	RAWELT			CROUSE-HINDS	PERFECT LINE	BWF
	Código Code	Catalogo Catalog	Catalogo Catalog	Catalogo Catalog	Catalogo Catalog	Catalogo Catalog
1/2	Sin orejas	01.01.0507	RR-0507	Sin orejas	FSLA1	
3/4	W/out lugs	01.01.0508	RR-0508	W/out lugs	FSLA2	
1		01.01.2745	RR-2745		FSLA3	
1/2	Con orejas	01.01.0507.M	RR-0507-M			
3/4	With lugs	01.01.0508.M	RR-0508-M			
1		01.01.2745.M	RR-2745-M			

3 ENTRADAS / 3 HUBS						
Medida Nominal Size	RAWELT			CROUSE-HINDS	PERFECT LINE	BWF
	Código Code	Catalogo Catalog	Catalogo Catalog	Catalogo Catalog	Catalogo Catalog	Catalogo Catalog
1/2	Sin orejas	01.01.0281	RR-0281	Sin orejas	FSCA1	Sin orejas B 5
3/4	W/out lugs	01.01.0282	RR-0282	W/out lugs	FSCA2	W/out lugs B 75
1		01.01.2746	RR-2746		FSCA3	B 100
1/2	Con orejas	01.01.0281.M	RR-0281-M		Con orejas T11-L	Con orejas BL 5
3/4	With lugs	01.01.0282.M	RR-0282-M		With lugs T14-L	With lugs BL 75
1		01.01.2746.M	RR-2746-M		T100-L	BL 100

4 ENTRADAS / 4 HUBS						
Medida Nominal Size	RAWELT			CROUSE-HINDS	PERFECT LINE	BWF
	Código Code	Catalogo Catalog	Catalogo Catalog	Catalogo Catalog	Catalogo Catalog	Catalogo Catalog
1/2	Sin orejas	01.01.0283	RR-0283		Sin orejas T11-2	Sin orejas B5-2
3/4	W/out lugs	01.01.0284	RR-0284		W/out lugs T14-2	W/out lugs B75-2
1/2	Con orejas	01.01.0283.M	RR-0283-M		Con orejas T11-2-L	Con orejas BL 5
3/4	With lugs	01.01.0284.M	RR-0284-M		With lugs T14-2-L	With lugs BL 75

RAWELT, S.A. de C.V.



Una División del Grupo **REVUELTA**

3.1, 3.2 - CAJA RECTANGULAR. A PRUEBA DE INTEMPERIE. SERIE RR.

3.1, 3.2 - WEATHERPROOF SINGLE GANG BOX. RR SERIES.

007-RW-259

**TABLA DE EQUIVALENCIAS.
CROSS REFERENCE GUIDE.**

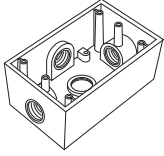
	4 ENTRADAS / 4 HUBS					
	Medida Nominal Size	RAWELT		CROUSE-HINDS	PERFECT LINE	BWF
		Código Code	Catalogo Catalog	Catalogo Catalog	Catalogo Catalog	Catalogo Catalog
1/2	Sin orejas	01.01.0454	RR-0454			
3/4	W/out lugs	01.01.0455	RR-0455			
1		01.01.2747	RR-2747			
1/2	Con orejas	01.01.0454.M	RR-0454-M			
3/4	With lugs	01.01.0455.M	RR-0455-M			
1		01.01.2747.M	RR-2747-M			

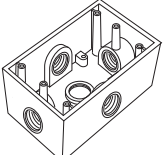
	5 ENTRADAS / 5 HUBS					
	Medida Nominal Size	RAWELT		CROUSE-HINDS	PERFECT LINE	BWF
		Código Code	Catalogo Catalog	Catalogo Catalog	Catalogo Catalog	Catalogo Catalog
1/2	Sin orejas	01.01.0285	RR-0285		Sin orejas TX11-5	Sin orejas B5-22X
3/4	W/out lugs	01.01.0286	RR-0286		W/out lugs TX14-5	W/out lugs B75-22X B100-22X
1		01.01.2748	RR-2748			
1/2	Con orejas	01.01.0285.M	RR-0285-M		Con orejas TX11-5L	Con orejas BL5-22X
3/4	With lugs	01.01.0286.M	RR-0286-M		With lugs TX14-5L	With lugs BL75-22X BL100-22X
1		01.01.2748.M	RR-2748-M			

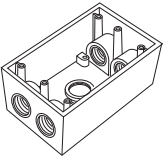
	5 ENTRADAS / 5 HUBS					
	Medida Nominal Size	RAWELT		CROUSE-HINDS	PERFECT LINE	BWF
		Código Code	Catalogo Catalog	Catalogo Catalog	Catalogo Catalog	Catalogo Catalog
1/2	Sin orejas	01.01.0287	RR-0287		Sin orejas T11-22	Sin orejas B5-22
3/4	W/out lugs	01.01.0288	RR-0288		W/out lugs T14-22	W/out lugs B75-22
1/2	Con orejas	01.01.0287.M	RR-0287-M		Con orejas T11-22L	Con orejas BL5-22
3/4	With lugs	01.01.0288.M	RR-0288-M		With lugs T14-22L	With lugs BL75-22

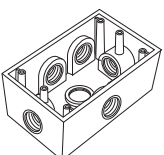
	6 ENTRADAS / 6 HUBS					
	Medida Nominal Size	RAWELT		CROUSE-HINDS	PERFECT LINE	BWF
		Código Code	Catalogo Catalog	Catalogo Catalog	Catalogo Catalog	Catalogo Catalog
1/2	Sin orejas	01.01.0289	RR-0289		Sin orejas TX11-6	
3/4	W/out lugs	01.01.0290	RR-0290		W/out lugs TX14-6	
1/2	Con orejas	01.01.0289.M	RR-0289-M		Con orejas TX11-6L	
3/4	With lugs	01.01.0290.M	RR-0290-M		With lugs TX14-6L	

Rawelt, S.A. de C.V. no asume ninguna responsabilidad por omisiones, errores, diferencias, en el diseño o función entre los productos arriba mencionados.

Rawelt, S.A. de C.V. assumes no liability for omission, errors, differences between bodies above mentioned or change in design or function.

RAWELT, S.A. de C.V.



Una División del Grupo REVUELTA

**3.2 - CAJA RECTANGULAR. A PRUEBA DE INTEMPERIE. SERIE RR.
CON OREJAS PARA MONTAJE.**

**3.2 - WEATHERPROOF SINGLE GANG BOX. RR SERIES.
WITH MOUNTING LUGS.**

Dimensiones en pulgadas y milímetros.
Dimensions in inches and millimeters.

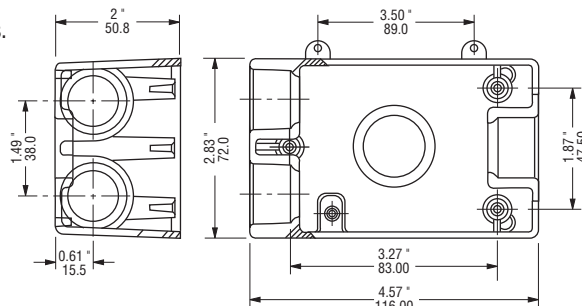

- Material: Aluminio inyectado a presión (diecast).
- Acabados: Pintura electrostática epoxica/poliéster polimerizada.
- Tornillo de tierra pasivado incluido.
- Dos orejas para montaje, tornillos y tapones incluidos.
- A prueba de intemperie cuando se usa tapa con empaque.
- Rosca NPT para usarse con tubo conduit RIGIDO e IMC.

APLICACIONES:

- Pueden ser instaladas para recibir accesorios como: Interruptores, contactos, estaciones de botones, luces piloto.
- Sirven para hacer empalmes y conexiones en el cableado. Permite fácil acceso para mantenimiento.
- Fabricación en base a: UL 514 A, UL 514 B
CAN/CSA - C22.2 No. 18-92

- Material: Diecast aluminum
- Finish: Electrostatic powder epoxy/polyester coating.
- Green ground screw included.
- Two mounting lugs, screws and close-up plugs included.
- For wet location when gasketed cover are used.
- NPT threaded for use with RIGID and IMC conduit.

APPLICATIONS:

- They can be installed to accommodate accessories such as switches, receptacles.
- Provide openings for making splice and taps. Allow access for maintenance.
- Manufactured in compliance with: UL 514 A, UL 514 B
CAN/CSA - C22.2 No. 18-92

USAR No. DE CODIGO PARA HACER PEDIDOS / TO ORDER USE CODE NUMBER

Figura Figure	Bocas Hubs	Catalogo Catalog	Codigo Code	Medida nominal Hub size		Volumen Volume		Peso x 100 pzas. Weight x 100 pcs.		Pqt. Unit. Pzas. Pcs.	Std. Pkg. Pzas. Pcs.	
				mm	inch	cm ³	cu. in	kg	Lb			
	Arriba/Top	1	RR-0505-M	01.01.0505.M	12.7	1/2	308.3	18.8	22.0	48.5	1	40
			RR-0506-M	01.01.0506.M	19.0	3/4	308.3	18.8	19.5	42.9	1	40
			RR-2631-M	01.01.2631.M	25.4	1	246.0	15.0	27.0	58.3	1	40
	Arriba/Top Abajo/Bottom	1	RR-0470-M	01.01.0470.M	12.7	1/2	300.1	18.3	24.0	52.9	1	40
		1	RR-0471-M	01.01.0471.M	19.0	3/4	295.2	18.0	22.0	48.5	1	40
			RR-2742-M	01.01.2742.M	25.4	1	246.0	15.0	27.0	58.3	1	40
	Arriba/Top Abajo/Bottom	1	RR-0472-M	01.01.0472.M	12.7	1/2	275.5	16.8	29.5	65.0	1	40
		2	RR-0473-M	01.01.0473.M	19.0	3/4	275.5	16.8	26.5	58.4	1	40
	Arriba/Top Abajo/Bottom Izquierda/Left	1	RR-0480-M	01.01.0480.M	12.7	1/2	275.5	16.8	30.0	66.1	1	40
		1	RR-0481-M	01.01.0481.M	19.0	3/4	275.5	16.8	27.5	60.6	1	40
		1	RR-2743-M	01.01.2743.M	25.4	1	234.5	14.3	28.5	62.7	1	40
	Arriba/Top Abajo/Bottom Izquierda/Left Derecha/Right	1	RR-0474-M	01.01.0474.M	12.7	1/2	275.5	16.8	32.5	71.6	1	40
		1	RR-0475-M	01.01.0475.M	19.0	3/4	275.5	16.8	26.5	58.4	1	40
		1	RR-2744-M	01.01.2744.M	25.4	1	234.5	14.3	28.5	62.7	1	40

Especificaciones sujetas a cambio sin previo aviso. Specifications are subject to change without notice.

RAWELT, S.A. de C.V.



**3.2 - CAJA RECTANGULAR. A PRUEBA DE INTEMPERIE. SERIE RR.
CON OREJAS PARA MONTAJE.**

**3.2 - WEATHERPROOF SINGLE GANG BOX. RR SERIES.
WITH MOUNTING LUGS.**

Hoja: 2 / 5
Page:

FICHA TECNICA / TECHNICAL DATA

007 - RW - 174

USAR No. DE CODIGO PARA HACER PEDIDOS / TO ORDER USE CODE NUMBER

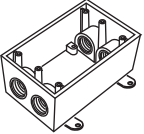
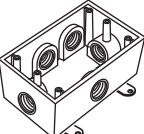
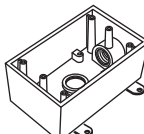
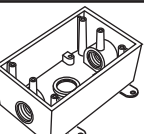
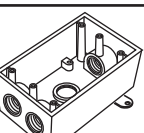
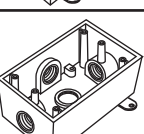
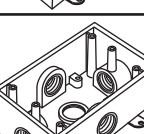
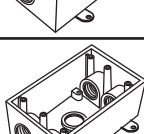
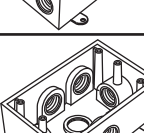
Figura Figure	Bocas Hubs	Catalogo Catalog	Codigo Code	Medida nominal Hub size		Volumen Volume		Peso x 100 pzas. Weight x 100 pcs.		Pqt. Unit. Pzas. Pcs.	Std. Pkg. Pzas. Pcs.
				mm	inch	cm ³	cu. in	kg	Lb		
	Arriba/Top 2	RR-0476-M	01.01.0476.M	12.7	1/2	267.3	16.3	30.5	67.2	1	40
	Abajo/Bottom 2	RR-0477-M	01.01.0477.M	19.0	3/4	267.3	16.3	26.0	57.3	1	40
	Arriba/Top 1	RR-0478-M	01.01.0478.M	12.7	1/2	267.3	16.3	32.0	70.5	1	40
	Abajo/Bottom 1	RR-0479-M	01.01.0479.M	19.0	3/4	267.3	16.3	28.5	62.8	1	40
	Izquierda/Left 2										
	Derecha/Right 1										
	Arriba/Top 1	RR-0507-M	01.01.0507.M	12.7	1/2	308.3	18.8	21.0	46.2	1	40
	Detrás/Back 1	RR-0508-M	01.01.0508.M	19.0	3/4	303.4	18.5	18.5	40.7	1	40
		RR-2745-M	01.01.2745.M	25.4	1	246.0	15.0	27.0	58.3	1	40
	Arriba/Top 1	RR-0281-M	01.01.0281.M	12.7	1/2	300.1	18.3	33.0	72.7	1	40
	Abajo/Bottom 1	RR-0282-M	01.01.0282.M	19.0	3/4	295.2	18.0	31.0	68.3	1	40
	Detrás/Back 1	RR-2746-M	01.01.2746.M	25.4	1	246.0	15.0	27.0	58.3	1	40
	Arriba/Top 1	RR-0283-M	01.01.0283.M	12.7	1/2	275.5	16.8	29.0	63.9	1	40
	Abajo/Bottom 2	RR-0284-M	01.01.0284.M	19.0	3/4	275.5	16.8	26.0	57.3	1	40
	Detrás/Back 1										
	Arriba/Top 1	RR-0454-M	01.01.0454.M	12.7	1/2	275.5	16.8	29.5	65.0	1	40
	Abajo/Bottom 1	RR-0455-M	01.01.0455.M	19.0	3/4	275.5	16.8	27.0	59.5	1	40
	Izquierda/Left 1										
	Detrás/Back 1	RR-2747-M	01.01.2747.M	25.4	1	234.5	14.3	28.5	62.7	1	40
	Arriba/Top 1	RR-0285-M	01.01.0285.M	12.7	1/2	275.5	16.8	32.0	70.5	1	40
	Abajo/Bottom 1	RR-0286-M	01.01.0286.M	19.0	3/4	275.5	16.8	26.0	57.3	1	40
	Izquierda/Left 1										
	Derecha/Right 1	RR-2748-M	01.01.2748.M	25.4	1	234.5	14.3	28.5	62.7	1	40
	Detrás/Back 1										
	Arriba/Top 2	RR-0287-M	01.01.0287.M	12.7	1/2	267.3	16.3	29.5	65.0	1	40
	Abajo/Bottom 2	RR-0288-M	01.01.0288.M	19.0	3/4	267.3	16.3	25.5	56.2	1	40
	Detrás/Back 1										
	Arriba/Top 1	RR-0289-M	01.01.0289.M	12.7	1/2	267.3	16.3	31.5	69.4	1	40
	Abajo/Bottom 1										
	Izquierda/Left 2	RR-0290-M	01.01.0290.M	19.0	3/4	267.3	16.3	28.0	61.7	1	40
	Derecha/Right 1										
	Detrás/Back 1										

Certificaciones / Compliances:  Expediente/File No. LR 105795-1

 Expediente/File No. E135600

 Cajas 25.4 1"
Boxes 25.4 1"

Especificaciones sujetas a cambio sin previo aviso. Specifications are subject to change without notice.

RAWELT, S.A. de C.V.

 **RAWELT** INYECTADOS

Una División del Grupo  **REVUELTA**

22 - V - 2009

**3.2 - CAJA RECTANGULAR. A PRUEBA DE INTEMPERIE. SERIE RR.
CON OREJAS PARA MONTAJE.**

Hoja: 3 / 5
Page:

**3.2 - WEATHERPROOF SINGLE GANG BOX. RR SERIES.
WITH MOUNTING LUGS.**

FICHA TECNICA / TECHNICAL DATA

007 - RW - 174

TAPA

- Lámina de aluminio troquelada.
- Uso en interiores.
- Tornillos galvanizados incluidos.

EMPAQUE

- Neopreno

TAPON

- Aluminio inyectado a presión (diecast).

COVER

- Sheet aluminum.
- For use indoors.
- Galvanized mounting screws included.

GASKET

- Neoprene.

CLOSE UP PLUG

- Die cast aluminum.

Dimensiones en milímetros y pulgadas.
Dimensions in inches and millimeters.

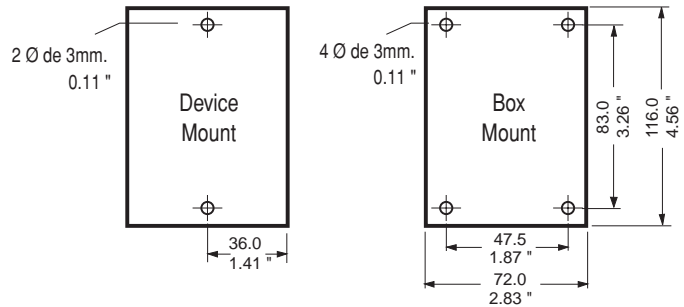

LISTED
1M70

USAR No. DE CODIGO PARA HACER PEDIDOS / TO ORDER USE CODE NUMBER

Figura Figure	Catalogo Catalog	Codigo Code	Descripción Description	Cant. Diam. Qty.	Espesor Thickness		Peso x 100 pzas. Weight x 100 pcs.		Pqt. Unit Pzas. Pcs.	Unit Ctn. Pzas. Pcs.	Ship Ctn. Pzas. Pcs.	Std. Pkg. Pzas. Pcs.
					mm.	inch	Kg	Lb				
	TR-0424	01.02.0424	Tapa rectangular para contacto de 35.23 mm Ø 1 3/8". Single gang round receptacle cover 1 3/8" diameter hole. Box mount.	4	1.02	.040	2.1	4.6	10	50	200	400
	TR-0414	01.02.0414	Tapa rectangular para contacto de 40.38 mm Ø 1 9/16". Single gang round receptacle cover 1 9/16" diameter hole. Box mount.	4	1.02	.040	2.0	4.4	10	50	200	400
	TR-0426	01.02.0426	Tapa rectangular para contacto de 54.30 mm Ø 2 1/8". Single gang round receptacle cover 2 1/8" diameter hole. Box mount.	4	1.02	.040	1.7	3.7	10	50	200	400
	TR-0425	01.02.0425	Tapa rectangular para contacto de 35.23 mm Ø 1 3/8". Single gang round receptacle cover 1 3/8" diameter hole. Device mount.	2	1.02	.040	2.1	4.6	10	50	200	400
	TR-0423	01.02.0423	Tapa rectangular para contacto de 40.38 mm Ø 1 9/16". Single gang round receptacle cover 1 9/16" diameter hole. Device mount.	2	1.02	.040	2.0	4.4	10	50	200	400
	TR-0427	01.02.0427	Tapa rectangular para contacto de 54.30 mm Ø 2 1/8". Single gang round receptacle cover 2 1/8" diameter hole. Device mount.	2	1.02	.040	1.8	4.0	10	50	200	400
	TR-0415	01.02.0415	Tapa rectangular para interruptor Single gang toggle switch cover. Box mount.	4	1.02	.040	2.3	5.1	10	50	200	400
	TR-0421	01.02.0421	Tapa rectangular para interruptor Single gang toggle switch cover. Device mount.	2	1.02	.040	2.3	5.1	10	50	200	400

Especificaciones sujetas a cambio sin previo aviso. Specifications are subject to change without notice.

RAWELT, S.A. de C.V.



Una División del Grupo REVUELTA

22 - V - 2009

**3.2 - CAJA RECTANGULAR. A PRUEBA DE INTEMPERIE. SERIE RR.
CON OREJAS PARA MONTAJE.**

**3.2 - WEATHERPROOF SINGLE GANG BOX. RR SERIES.
WITH MOUNTING LUGS.**

Hoja: 4 / 5
Page:

FICHA TECNICA / TECHNICAL DATA

007-RW-174

USAR No. DE CODIGO PARA HACER PEDIDOS / TO ORDER USE CODE NUMBER

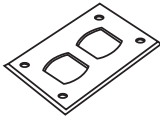
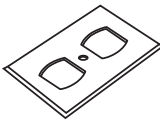
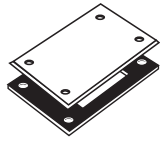
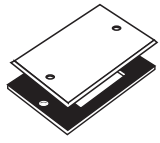
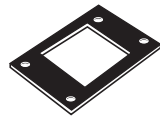
Figura Figure	Catalogo Catalog	Codigo Code	Descripción Description	Cant. Diam. Qty.	Espesor Thickness		Peso x 100 pzas. Weight x 100 pcs.		Pqt. Unit Pzas. Pcs.	Unit Ctn. Pzas. Pcs.	Ship Ctn. Pzas. Pcs.	Std. Pkg. Pzas. Pcs.
					mm	inch	kg	Lb				
	TR-0385	01.02.0385	Tapa rectangular para contacto duplex. Single gang duplex receptacle cover. Box mount.	4	1.02	.040	2.0	4.4	10	50	200	400
	TR-0422	01.02.0422	Tapa rectangular para contacto duplex. Single gang duplex receptacle cover. Device mount.	1	1.02	.040	1.9	4.2	10	50	200	400
	TR-0416	01.02.1309.G	Tapa rectangular ciega con empaque. Weatherproof single gang blank cover. Box mount with gasket.	4	1.02	.040	2.4	5.3	10	40	160	330
	ERN-0429											
	TR-0420	01.02.1310.G	Tapa rectangular ciega con empaque. Weatherproof single gang blank cover. Device mount with gasket.	2	1.02	.040	2.4	5.3	10	40	160	330
	ERN-0429											
	ERN-0429	01.05.0429	Empaque de Neopreno tipo rectangular. Neoprene gasket.	4	1.6	1/16	1.0	2.2	10	100	700	

TAPONES / PLUGS

USAR No. DE CODIGO PARA HACER PEDIDOS / TO ORDER USE CODE NUMBER

Figura Figure	Catalogo Catalog	Codigo Code	Descripción Description	Medida nominal Hub size		Peso x 100 pzas. Weight x 100 pcs.		Pqt. Unit Pzas. Pcs.	Unit Ctn. Pzas. Pcs.	Ship Ctn. Pzas. Pcs.
				mm.	inch	kg	Lb			
	TA-0371	01.04.0371	Tapón roscado.	12.7	1/2	1.0	2.2	25	200	2000
	TA-0368	01.04.0368	Close-up plug.	19.0	3/4	1.3	2.9	25	100	1000
	TA-2632	01.04.2632		25.4	1	1.7	3.7	25	100	1000

Certificaciones / Compliances:  Expediente/File No. LR 105795-1



Expediente/File No. E135600

 Tapones
Closure plugs

Especificaciones sujetas a cambio sin previo aviso. Specifications are subject to change without notice..

RAWELT, S.A. de C.V.

 **RAWELT** INYECTADOS
Una División del Grupo **REVUELTA**

22 - V - 2009

**3.2 - CAJA RECTANGULAR. A PRUEBA DE INTEMPERIE. SERIE RR.
CON OREJAS PARA MONTAJE.**

**3.2 - WEATHERPROOF SINGLE GANG BOX. RR SERIES.
WITH MOUNTING LUGS.**



TAPA

- Material: Aluminio inyectado a presión (diecast).
- Acabados: Pintura electrostática epoxica/poliéster polimerizada.
- Para uso en interiores y exteriores.
- Provee protección contra la intemperie cuando el receptáculo no esta en uso.
- Empaque y tornillos galvanizados incluidos.
- Contratapa con mecanismo de auto-cierre.

COVER

- Diecast aluminum.
- Finish: Electrostatic powder epoxy/poliéster coating.
- For use indoors and outdoors.
- Provides weatherproof protection when the receptacle is not in use.
- Gasket and galvanized mounting screws included.
- Self-closing cover.

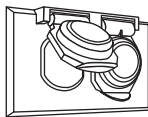
USAR No. DE CODIGO PARA HACER PEDIDOS / TO ORDER USE CODE NUMBER

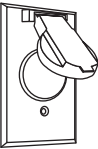
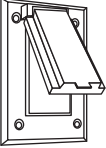
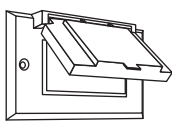
Figura Figure	Catalogo Catalog	Codigo Code	Descripción Description	Cant. Diam. Qty.	Peso x 100 pzas. Weight x 100 pcs.		Pqt. Unit Pzas. Pcs.	Unit Ctn. Pzas. Pcs.	Ship Ctn. Pzas. Pcs.	Std Pkg. Pzas. Pcs.
					kg	Lb				
	TR-0611	01.03.0611	Tapa rectangular a prueba de intemperie para contacto duplex horizontal. Weatherproof single gang horizontal cover for duplex receptacles.	1	16.0	35.0	1	12	48	96
	TR-0567	01.03.0567	Tapa rectangular a prueba de intemperie para contacto duplex vertical. Weatherproof single gang vertical cover for duplex receptacles.	1	13.0	29.0	1	12	48	96
	TR-0563	01.03.0563	Tapa rectangular a prueba de intemperie para contacto de 37.5 mm (1.47"). Weatherproof single gang round receptacle cover with 1.47" diameter hole.	2	13.0	29.0	1	12	48	96
	TR-0565	01.03.0565	Tapa rectangular a prueba de intemperie para contacto GFCI vertical. Weatherproof single gang vertical cover for GFCI receptacles.	4	14.0	31.0	1	12	48	96
	TR-3251	01.03.3251	Tapa rectangular a prueba de intemperie para contacto GFCI horizontal. Weatherproof single gang horizontal cover for GFCI receptacles.	2	15.5	34.0	1	12	48	96

Especificaciones sujetas a cambio sin previo aviso. Specifications are subject to change without notice.

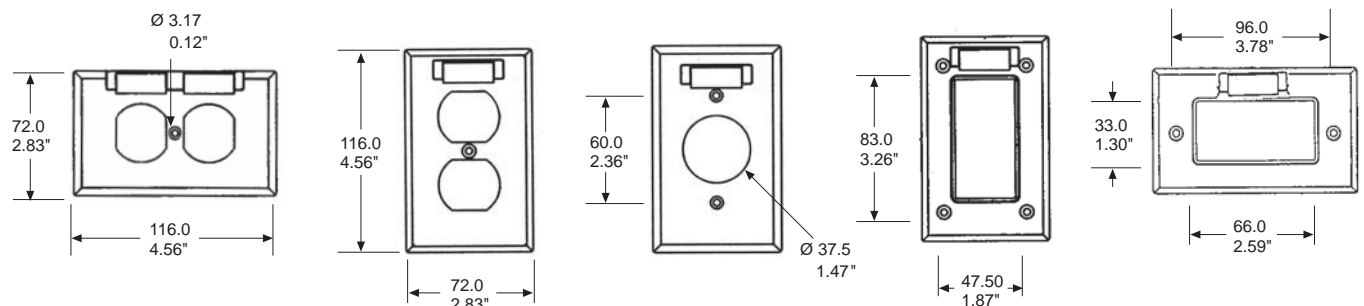

Dimensiones en milímetros y pulgadas. Dimensions in millimeters and inches.

RAWELT, S.A. de C.V.



03 - IX - 2007

Cotización/Quotation Plazo de embarque* / Shipment exw* :

Pedido No./Purchase order :

Our ref.:

Fecha/Date: Vendedor/Salesman: No.

Facturar a/Invoice to: RFC.

Ordenado por/Ordered by: Tel. () Fax ()

Dirección/Address:

C.P./Zip. Lugar/City/Country:















Consignar a/Ship to:

Embarcar: Camión x Cobrar Pagado Paquete

Cond. de Pago/Terms:

Cond. de Venta/Sale conditions: L.P.:

3.2 - SERIE RR. CAJA RECTANGULAR A PRUEBA DE INTEMPERIE CON OREJAS / WEATHERPROOF SINGLE GANG BOX WITH M. LUGS.

Figura Figure	Código Code	Medida nominal Hub size		Pqt. Unit.	Unit. Ctn.	Ship Ctn.	Std. Pkg.	Cantidad Qty.	Figura Figure	Código Code	Medida nominal Hub size		Pqt. Unit.	Std. Pkg.	Cantidad Qty.	
		mm	inch								Pzas. Pcs.	Pzas. Pcs.				mm
	01.01.0505.M	12.7	1/2	1			40			01.01.0507.M	12.7	1/2	1	40		
	01.01.0506.M	19.0	3/4	1			40			01.01.0508.M	19.0	3/4	1	40		
	01.01.2631.M	25.4	1	1			40			01.01.2745.M	25.4	1	1	40		
	01.01.0470.M	12.7	1/2	1			40			01.01.0281.M	12.7	1/2	1	40		
	01.01.0471.M	19.0	3/4	1			40			01.01.0282.M	19.0	3/4	1	40		
	01.01.2742.M	25.4	1	1			40			01.01.2746.M	25.4	1	1	40		
	01.01.0472.M	12.7	1/2	1			40			01.01.0283.M	12.7	1/2	1	40		
	01.01.0473.M	19.0	3/4	1			40			01.01.0284.M	19.0	3/4	1	40		
	01.01.0480.M	12.7	1/2	1			40			01.01.0454.M	12.7	1/2	1	40		
	01.01.0481.M	19.0	3/4	1			40			01.01.0455.M	19.0	3/4	1	40		
	01.01.2743.M	25.4	1	1			40			01.01.2747.M	25.4	1	1	40		
	01.01.0474.M	12.7	1/2	1			40			01.01.0285.M	12.7	1/2	1	40		
	01.01.0475.M	19.0	3/4	1			40			01.01.0286.M	19.0	3/4	1	40		
	01.01.2744.M	25.4	1	1			40			01.01.2748.M	25.4	1	1	40		
	01.01.0476.M	12.7	1/2	1			40			01.01.0287.M	12.7	1/2	1	40		
	01.01.0477.M	19.0	3/4	1			40			01.01.0288.M	19.0	3/4	1	40		
	01.01.0478.M	12.7	1/2	1			40			01.01.0289.M	12.7	1/2	1	40		
	01.01.0479.M	19.0	3/4	1			40			01.01.0290.M	19.0	3/4	1	40		
	01.04.0371.M	12.7	1/2	25	200	2000										
	01.04.0368.M	19.0	3/4	25	100	1000										
	01.04.2632.M	25.4	1	25	100	1000										

Expediente
 Control
 Embarques
 Almacén
 Producción

- Antes de fincar el pedido en firme, favor de confirmar con fábrica el plazo de embarque definitivo.
- Before place your order, please confirm with RAWELT definitive date of shipment.

Cotización/Quotation Plazo de embarque* / Shipment exw* :

 Pedido No./Purchase order : _____

Our ref.: _____

Fecha/Date: _____ Vendedor/Salesman: _____ No. _____

Facturar a/Invoice to: _____ RFC: _____

Ordenado por/Ordered by: _____ Tel. () _____ Fax () _____

Dirección/Address: _____







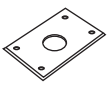
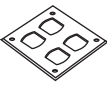

C.P./Zip: _____ Lugar/City/Country: _____

Consignar a/Ship to: _____

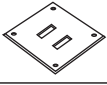
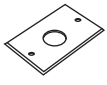
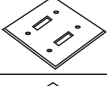
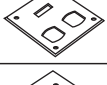
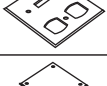
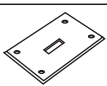
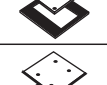
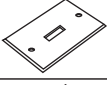
 Embarcar: Camión x Cobrar Pagado Paquete

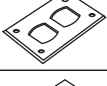
Cond. de Pago/Terms: _____

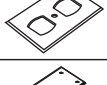
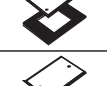
Cond. de Venta/Sale conditions: _____ L.P.: _____

3. - SERIE RR. TAPA Y EMPAQUE / COVER AND GASKET.							4. - SERIE RC. TAPA Y EMPAQUE/COVER AND GASKET.							<input type="checkbox"/> Expediente <input type="checkbox"/> Control <input type="checkbox"/> Embarques <input type="checkbox"/> Almacén <input type="checkbox"/> Producción	
Figura Figure	Código Code	Diametro Ø	Pqt. Unit. Pzas. Pcs.	Unit. Ctn. Pzas. Pcs.	Ship. Ctn. Pzas. Pcs.	Std. Pkg. Pzas. Pcs.	Cantidad Qty.	Figura Figure	Código Code	Pqt. Unit. Pzas. Pcs.	Unit. Ctn. Pzas. Pcs.	Ship. Ctn. Pzas. Pcs.	Std. Pkg. Pzas. Pcs.		Cantidad Qty.
	01.02.0424	Ø 35.23 mm	10	50	200	400			02.02.0417	10	40	160	200		
	01.02.0414	Ø 40.38 mm	10	50	200	400				02.02.0457	10	40	160		200
	01.02.0426	Ø 54.30 mm	10	50	200	400					02.02.0419	10	40		160
	01.02.0425	Ø 35.23 mm	10	50	200	400			02.02.0459		10	40	160	200	
	01.02.0423	Ø 40.38 mm	10	50	200	400				02.02.0510	10	40	160	200	
	01.02.0427	Ø 54.30 mm	10	50	200	400					02.02.0511	10	40	160	
	01.02.0415		10	50	200	400			02.02.1311.G		10	40	120	200	
	01.02.0421		10	50	200	400				02.02.1312.G	10	40	120	200	
	01.02.0385		10	50	200	400				02.04.0430 1/16	10	120	480		
	01.02.0422		10	50	200	400									
	01.02.1309.G		10	40	160	330									
	01.02.1310.G		10	40	160	330									
	01.05.0429 1/16		10	100	700										

- Antes de fincar el pedido en firme, favor de confirmar con fábrica el plazo de embarque definitivo.
- Before place your order, please confirm with RAWELT definitive date of shipment.

Cotización/Quotation Plazo de embarque* / Shipment exw* :

 Pedido No./Purchase order :

Our ref.:

Fecha/Date: Vendedor/Salesman: No.

Facturar a/Invoice to: RFC:

Ordenado por/Ordered by: Tel. () Fax ()

Dirección/Address:







C.P./Zip: Lugar/City/Country:

Consignar a/Ship to:

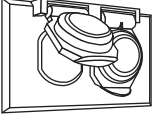
 Embarcar: Camión x Cobrar Pagado Paquete

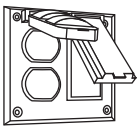
Cond. de Pago/Terms:

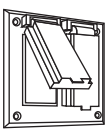
Cond. de Venta/Sale conditions: L.P.:

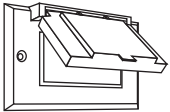
3.- SERIE RR. TAPA A PRUEBA DE INTEMPERIE/WEATHERPROOF COVER.							4.- SERIE RC. TAPA A PRUEBA DE INTEMPERIE/WEATHERPROOF COVER.						
Figura Figure	Código Code	Pqt. Unit. Pzas. Pcs.	Unit. Ctn. Pzas. Pcs.	Ship. Ctn. Pzas. Pcs.	Std. Pkg. Pzas. Pcs.	Cantidad Qty.	Figura Figure	Código Code	Pqt. Unit. Pzas. Pcs.	Unit. Ctn. Pzas. Pcs.	Ship. Ctn. Pzas. Pcs.	Std. Pkg. Pzas. Pcs.	Cantidad Qty.
	01.03.0611	1	12	48	96			02.03.0568	1	8	32	64	
	01.03.0567	1	12	48	96			02.03.3252	1	8	32	64	
	01.03.0563	1	12	48	96			02.03.3253	1	8	32	64	
	01.03.0565	1	12	48	96								
	01.03.3251	1	12	48	96								

 Expediente
 Control
 Embarques
 Almacén
 Producción

- Antes de fincar el pedido en firme, favor de confirmar con fábrica el plazo de embarque definitivo.
- Before place your order, please confirm with RAWELT definitive date of shipment.

3.1, 3.2 - CAJA RECTANGULAR. A PRUEBA DE INTEMPERIE. SERIE RR.

3.1, 3.2 - WEATHERPROOF SINGLE GANG BOX. RR SERIES.

007-RW-259

**TABLA DE EQUIVALENCIAS.
CROSS REFERENCE GUIDE.**

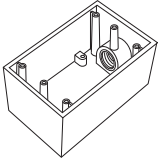
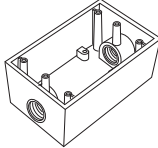
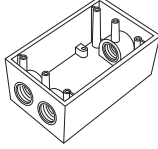
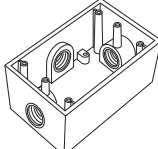
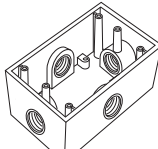
1 ENTRADA / 1 HUB							
	Medida Nominal Size	RAWELT		CROUSE-HINDS		PERFECT LINE	BWF
		Código Code	Catalogo Catalog	Catalogo Catalog		Catalogo Catalog	Catalogo Catalog
	1/2	Sin orejas	01.01.0505	RR-0505	Sin orejas	FS1	
	3/4	W/out lugs	01.01.0506	RR-0506	W/out lugs	FS2	
	1		01.01.2631	RR-2631		FS3	
	1/2	Con orejas	01.01.0505.M	RR-0505-M			
	3/4	With lugs	01.01.0506.M	RR-0506-M			
	1		01.01.2631.M	RR-2631-M			
2 ENTRADAS / 2 HUBS							
	Medida Nominal Size	RAWELT		CROUSE-HINDS		PERFECT LINE	BWF
		Código Code	Catalogo Catalog	Catalogo Catalog		Catalogo Catalog	Catalogo Catalog
	1/2	Sin orejas	01.01.0470	RR-0470	Sin orejas	FSC1	
	3/4	W/out lugs	01.01.0471	RR-0471	W/out lugs	FSC2	
	1		01.01.2742	RR-2742		FSC3	
	1/2	Con orejas	01.01.0470.M	RR-0470-M			
	3/4	With lugs	01.01.0471.M	RR-0471-M			
	1		01.01.2742.M	RR-2742-M			
3 ENTRADAS / 3 HUBS							
	Medida Nominal Size	RAWELT		CROUSE-HINDS		PERFECT LINE	BWF
		Código Code	Catalogo Catalog	Catalogo Catalog		Catalogo Catalog	Catalogo Catalog
	1/2	Sin orejas	01.01.0472	RR-0472	Sin orejas	FSCC1	
	3/4	W/out lugs	01.01.0473	RR-0473	W/out lugs	FSCC2	
	1/2	Con orejas	01.01.0472.M	RR-0472-M			
	3/4	With lugs	01.01.0473.M	RR-0473-M			
3 ENTRADAS / 3 HUBS							
	Medida Nominal Size	RAWELT		CROUSE-HINDS		PERFECT LINE	BWF
		Código Code	Catalogo Catalog	Catalogo Catalog		Catalogo Catalog	Catalogo Catalog
	1/2	Sin orejas	01.01.0480	RR-0480	Sin orejas	FSCT1	
	3/4	W/out lugs	01.01.0481	RR-0481	W/out lugs	FSCT2	
	1		01.01.2743	RR-2743		FSCT3	
	1/2	Con orejas	01.01.0480.M	RR-0480-M			
	3/4	With lugs	01.01.0481.M	RR-0481-M			
	1		01.01.2743.M	RR-2743-M			
4 ENTRADAS / 4 HUBS							
	Medida Nominal Size	RAWELT		CROUSE-HINDS		PERFECT LINE	BWF
		Código Code	Catalogo Catalog	Catalogo Catalog		Catalogo Catalog	Catalogo Catalog
	1/2	Sin orejas	01.01.0474	RR-0474	Sin orejas	FSX1	
	3/4	W/out lugs	01.01.0475	RR-0475	W/out lugs	FSX2	
	1		01.01.2744	RR-2744		FSX3	
	1/2	Con orejas	01.01.0474.M	RR-0474-M			
	3/4	With lugs	01.01.0475.M	RR-0475-M			
	1		01.01.2744.M	RR-2744-M			

RAWELT, S.A. de C.V.



3.1, 3.2 - CAJA RECTANGULAR. A PRUEBA DE INTEMPERIE. SERIE RR.

Hoja: 2 / 3
Page:

FICHA TECNICA / TECHNICAL DATA

3.1, 3.2 - WEATHERPROOF SINGLE GANG BOX. RR SERIES.

007-RW-259

**TABLA DE EQUIVALENCIAS.
CROSS REFERENCE GUIDE.**

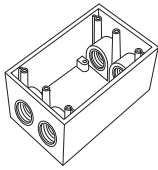
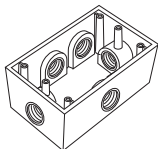
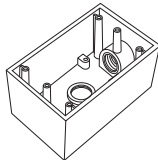
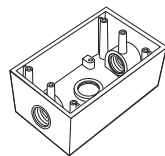
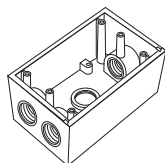
4 ENTRADAS / 4 HUBS									
Medida Nominal Size	RAWELT			CROUSE-HINDS	PERFECT LINE	BWF			
	Código Code	Catalogo Catalog	Catalogo Catalog	Catalogo Catalog	Catalogo Catalog	Catalogo Catalog			
	1/2	Sin orejas	01.01.0476	RR-0476	Sin orejas	FSCD1			
	3/4	W/out lugs	01.01.0477	RR-0477	W/out lugs	FSCD2			
	1/2	Con orejas	01.01.0476.M	RR-0476-M					
	3/4	With lugs	01.01.0477.M	RR-0477-M					
5 ENTRADAS / 5 HUBS									
Medida Nominal Size	RAWELT			CROUSE-HINDS	PERFECT LINE	BWF			
	Código Code	Catalogo Catalog	Catalogo Catalog	Catalogo Catalog	Catalogo Catalog	Catalogo Catalog			
	1/2	Sin orejas	01.01.0478	RR-0478					
	3/4	W/out lugs	01.01.0479	RR-0479					
	1/2	Con orejas	01.01.0478.M	RR-0478-M					
	3/4	With lugs	01.01.0479.M	RR-0479-M					
2 ENTRADAS / 2 HUBS									
Medida Nominal Size	RAWELT			CROUSE-HINDS	PERFECT LINE	BWF			
	Código Code	Catalogo Catalog	Catalogo Catalog	Catalogo Catalog	Catalogo Catalog	Catalogo Catalog			
	1/2	Sin orejas	01.01.0507	RR-0507	Sin orejas	FSLA1			
	3/4	W/out lugs	01.01.0508	RR-0508	W/out lugs	FSLA2			
		1		01.01.2745	RR-2745		FSLA3		
	1/2	Con orejas	01.01.0507.M	RR-0507-M					
	3/4	With lugs	01.01.0508.M	RR-0508-M					
		1		01.01.2745.M	RR-2745-M				
3 ENTRADAS / 3 HUBS									
Medida Nominal Size	RAWELT			CROUSE-HINDS	PERFECT LINE	BWF			
	Código Code	Catalogo Catalog	Catalogo Catalog	Catalogo Catalog	Catalogo Catalog	Catalogo Catalog			
	1/2	Sin orejas	01.01.0281	RR-0281	Sin orejas	FSCA1	Sin orejas	B 5	
	3/4	W/out lugs	01.01.0282	RR-0282	W/out lugs	FSCA2	W/out lugs	B 75	
		1		01.01.2746	RR-2746		FSCA3		B 100
	1/2	Con orejas	01.01.0281.M	RR-0281-M		Con orejas	T11-L	Con orejas	BL 5
	3/4	With lugs	01.01.0282.M	RR-0282-M		With lugs	T14-L	With lugs	BL 75
		1		01.01.2746.M	RR-2746-M			T100-L	
4 ENTRADAS / 4 HUBS									
Medida Nominal Size	RAWELT			CROUSE-HINDS	PERFECT LINE	BWF			
	Código Code	Catalogo Catalog	Catalogo Catalog	Catalogo Catalog	Catalogo Catalog	Catalogo Catalog			
	1/2	Sin orejas	01.01.0283	RR-0283		Sin orejas	T11-2	Sin orejas	B5-2
	3/4	W/out lugs	01.01.0284	RR-0284		W/out lugs	T14-2	W/out lugs	B75-2
	1/2	Con orejas	01.01.0283.M	RR-0283-M		Con orejas	T11-2-L	Con orejas	BL 5
	3/4	With lugs	01.01.0284.M	RR-0284-M		With lugs	T14-2-L	With lugs	BL 75

RAWELT, S.A. de C.V.



Una División del Grupo **REVUELTA**

3.1, 3.2 - CAJA RECTANGULAR. A PRUEBA DE INTEMPERIE. SERIE RR.

3.1, 3.2 - WEATHERPROOF SINGLE GANG BOX. RR SERIES.

007-RW-259

**TABLA DE EQUIVALENCIAS.
CROSS REFERENCE GUIDE.**

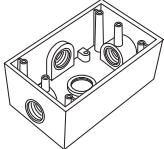
	4 ENTRADAS / 4 HUBS					
	Medida Nominal Size	RAWELT		CROUSE-HINDS	PERFECT LINE	BWF
		Código Code	Catalogo Catalog	Catalogo Catalog	Catalogo Catalog	Catalogo Catalog
1/2	Sin orejas	01.01.0454	RR-0454			
3/4	W/out lugs	01.01.0455	RR-0455			
1		01.01.2747	RR-2747			
1/2	Con orejas	01.01.0454.M	RR-0454-M			
3/4	With lugs	01.01.0455.M	RR-0455-M			
1		01.01.2747.M	RR-2747-M			

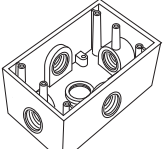
	5 ENTRADAS / 5 HUBS					
	Medida Nominal Size	RAWELT		CROUSE-HINDS	PERFECT LINE	BWF
		Código Code	Catalogo Catalog	Catalogo Catalog	Catalogo Catalog	Catalogo Catalog
1/2	Sin orejas	01.01.0285	RR-0285		Sin orejas TX11-5	Sin orejas B5-22X
3/4	W/out lugs	01.01.0286	RR-0286		W/out lugs TX14-5	W/out lugs B75-22X B100-22X
1		01.01.2748	RR-2748			
1/2	Con orejas	01.01.0285.M	RR-0285-M		Con orejas TX11-5L	Con orejas BL5-22X
3/4	With lugs	01.01.0286.M	RR-0286-M		With lugs TX14-5L	With lugs BL75-22X BL100-22X
1		01.01.2748.M	RR-2748-M			

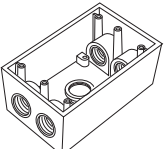
	5 ENTRADAS / 5 HUBS					
	Medida Nominal Size	RAWELT		CROUSE-HINDS	PERFECT LINE	BWF
		Código Code	Catalogo Catalog	Catalogo Catalog	Catalogo Catalog	Catalogo Catalog
1/2	Sin orejas	01.01.0287	RR-0287		Sin orejas T11-22	Sin orejas B5-22
3/4	W/out lugs	01.01.0288	RR-0288		W/out lugs T14-22	W/out lugs B75-22
1/2	Con orejas	01.01.0287.M	RR-0287-M		Con orejas T11-22L	Con orejas BL5-22
3/4	With lugs	01.01.0288.M	RR-0288-M		With lugs T14-22L	With lugs BL75-22

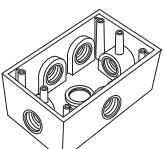
	6 ENTRADAS / 6 HUBS					
	Medida Nominal Size	RAWELT		CROUSE-HINDS	PERFECT LINE	BWF
		Código Code	Catalogo Catalog	Catalogo Catalog	Catalogo Catalog	Catalogo Catalog
1/2	Sin orejas	01.01.0289	RR-0289		Sin orejas TX11-6	
3/4	W/out lugs	01.01.0290	RR-0290		W/out lugs TX14-6	
1/2	Con orejas	01.01.0289.M	RR-0289-M		Con orejas TX11-6L	
3/4	With lugs	01.01.0290.M	RR-0290-M		With lugs TX14-6L	

Rawelt, S.A. de C.V. no asume ninguna responsabilidad por omisiones, errores, diferencias, en el diseño o función entre los productos arriba mencionados.

Rawelt, S.A. de C.V. assumes no liability for omission, errors, differences between bodies above mentioned or change in design or function.

RAWELT, S.A. de C.V.



Una División del Grupo REVUELTA